

SP25M user's guide

www.renishaw.com

SP25M user's guide

Document part number: H-1000-5104-08-B



SP25M user's guide

www.renishaw.com

SP25M general information

© 2005 - 2023 Renishaw plc. All rights reserved.

 ORIGINAL LANGUAGE VERSION

This document may not be copied or reproduced in whole or in part, or transferred to any other media or language by any means, without the prior written permission of Renishaw.

Disclaimer

WHILE CONSIDERABLE EFFORT WAS MADE TO VERIFY THE ACCURACY OF THIS DOCUMENT AT PUBLICATION, ALL WARRANTIES, CONDITIONS, REPRESENTATIONS AND LIABILITY, HOWSOEVER ARISING, ARE EXCLUDED TO THE EXTENT PERMITTED BY LAW.

RENISHAW RESERVES THE RIGHT TO MAKE CHANGES TO THIS DOCUMENT AND TO THE EQUIPMENT, AND/OR SOFTWARE AND THE SPECIFICATION DESCRIBED HEREIN WITHOUT OBLIGATION TO PROVIDE NOTICE OF SUCH CHANGES.

Trade marks

RENISHAW®, the probe symbol and REVO® are registered trade marks of Renishaw plc.

Renishaw product names, designations and the mark 'apply innovation' are trade marks of Renishaw plc or its subsidiaries.

Other brand, product or company names are trade marks of their respective owners.

WEEE



The use of this symbol on Renishaw products and / or accompanying documentation indicates that the product should not be mixed with general household waste upon disposal. It is the responsibility of the end user to dispose of this product at a designated collection point for waste electrical and electronic equipment (WEEE) to enable reuse or recycling. Correct disposal of this product will help to save valuable resources and prevent potential negative effects on the environment. For more information, please contact your local waste disposal service or Renishaw distributor.

Warranty

Unless you and Renishaw have agreed and signed a separate written agreement, the equipment and/or software are sold subject to the Renishaw Standard Terms and Conditions supplied with such equipment and/or software, or available on request from your local Renishaw office.

Renishaw warrants its equipment and software for a limited period (as set out in the Standard Terms and Conditions), provided that they are installed and used exactly as defined in associated Renishaw documentation. You should consult these Standard Terms and Conditions to find out the full details of your warranty.

Equipment and/or software purchased by you from a third-party supplier is subject to separate terms and conditions supplied with such equipment and/or software. You should contact your third-party supplier for details.

SP25M user's guide

www.renishaw.com

Care of equipment

Renishaw probes and associated systems are precision tools used for obtaining precise measurements and must therefore be treated with care.

Changes to Renishaw products

Renishaw reserves the right to improve, change or modify its hardware or software without incurring any obligations to make changes to Renishaw equipment previously sold.

Company registration details

Renishaw plc. Registered in England and Wales. Company no: 1106260. Registered office: New Mills, Wotton-under-Edge, Gloucestershire, GL12 8JR, UK.

Packaging

To aid end user recycling and disposal the materials used in the different components of the packaging are stated here:

Packaging component	Material	94/62/EC code	94/62/EC number
Outer box	Non-corrugated fibreboard	PAP	21
Outer box	Corrugated fibreboard	PAP	20
Storage box	Polypropylene	PP	5
Packing foam	Low density polyethylene	LDPE	4



CAUTION: If it is necessary to return any part of the system please ensure it is packaged carefully. Failure to do so could result in transit damage for which the customer would be liable. Products supplied in plastic boxes must be returned in the original packaging.

Patents

Features of Renishaw's SP25M system and associated products are the subjects of one or more of the following patents and patent applications:

US6772527

SP25M user's guide

www.renishaw.com

SP25M product compliance

EU declaration of conformity

Contact Renishaw plc or visit www.renishaw.com/EUCMM for the full EU declaration.

UK declaration of conformity

Contact Renishaw plc or visit www.renishaw.com/UKCMM for the full UK declaration.

EMC conformity

This equipment must be installed and used in accordance with this installation guide. This product is intended for industrial use only and should not be used in a residential area or connected to a low voltage power supply network which supplies buildings used for residential purposes.

FCC (USA only)

Information to user (47 CFR 15.105)

This equipment has been tested and found to comply with the limits for a Class A digital device, pursuant to Part 15 of the FCC rules. These limits are designed to provide reasonable protection against harmful interference when the equipment is operated in a commercial environment. This equipment generates, uses, and can radiate radio frequency energy and, if not installed and used in accordance with the instruction manual, may cause harmful interference to radio communications. Operation of this equipment in a residential area is likely to cause harmful interference, in which case you will be required to correct the interference at your own expense.

Information to user (47 CFR 15.21)

The user is cautioned that any changes or modifications not expressly approved by Renishaw plc or authorised representative could void the user's authority to operate the equipment.

Equipment label (47 CFR 15.19)

This device complies with part 15 of the FCC Rules. Operation is subject to the following two conditions:

1. This device may not cause harmful interference.
 2. This device must accept any interference received, including interference that may cause undesired operation.
-

SP25M user's guide

www.renishaw.com

ICES-003 (Canada only)

Class A Equipment Statement (non-residential)

CAN ICES-003(A) / NMB-003(A)

REACH regulation

Information required by Article 33(1) of Regulation (EC) No. 1907/2006 ("REACH") relating to products containing substances of very high concern (SVHCs) is available at:

www.renishaw.com/REACH

China RoHS

Contact Renishaw plc or visit www.renishaw.com/ChinaRoHSCMM for the full China RoHS tabulation.



SP25M user's guide

www.renishaw.com

SP25M international safety instructions

BG - ПРЕДУПРЕЖДЕНИЕ

Моля, обърнете на приложение 1 и прочетете инструкциите за безопасност на вашия собствен език, преди за разопаковате и монтирате този продукт.

CZ - VÝSTRAHA

Před rozbalením a instalací tohoto výrobku si přečtěte bezpečnostní pokyny ve vlastním jazyce uvedené v příloze 1.

DA - ADVARSEL

Læs sikkerhedsinstrukserne i Appendix 1 FØR udpakning og installation af dette produkt.

DE - WARNHINWEIS

Bevor Sie dieses Produkt auspacken und installieren, konsultieren Sie bitte Anhang 1 und lesen Sie die Sicherheitshinweise in Ihrer Sprache.

EL - ΠΡΟΕΙΔΟΠΟΙΗΣΗ

Γυρίστε στο Κεφάλαιο 1 και διαβάστε τις οδηγίες ασφαλείας στη δική σας γλώσσα προτού ανοίξετε αυτό το προϊόν για να το εγκαταστήσετε.

EN - WARNING

Before unpacking and installing this product, please consult Appendix 1 and read the safety instructions in your language.

ES - ADVERTENCIA

Consulte el apéndice 1 y lea las instrucciones de seguridad en su idioma antes de desempaquetar e instalar este producto.

ET - HOIATUS

Palun vaadake 1. lisa ning lugege enne selle toote lahtipakkimist ja paigaldamist ohutusjuhend läbi.

FI - VAROITUKSIA

Lue liitteessä 1 olevat omalla kielelläsi kirjoitetut turvaohjeet ennen tämän tuotteen pakkauksen avaamista ja asentamista.

FR - AVERTISSEMENT

Consulter l'annexe 1 et les instructions de sécurité dans votre propre langue avant de débiller et d'installer ce produit.

SP25M user's guide

www.renishaw.com

GA - RABHADH

Téigh chuig aguisín 1 agus déan na treoracha sábháilteachta a léamh i do theanga féin le do thoil sula ndéantar an táirge seo a dhíphacáil agus a shuiteáil.

HR - NAPOMENA

Prije nego što proizvod izvadite iz ambalaže i ugradite ga, otvorite Prilog 1 i pročitajte sigurnosne upute na svom jeziku.

HU – FIGYELMEZTETÉS

A termék kicsomagolása és telepítése előtt olvassa el az 1. számú függelékben található, az Ön anyanyelvén hozzáférhető biztonsági utasításokat.

IT - AVVISO

Prima di aprire ed installare questo prodotto, leggere le istruzioni di sicurezza nella vostra lingua riportate nell'Appendice 1.

JA - 警告

この製品を箱から取り出し設置する前に、付録 1 に記載された安全性に関する注意書きをお読みください。

LT – ĮSPĖJIMAS

Prieš išpakuodami ir įdiegdami produktą, turite grįžti prie 1 priedo ir perskaityti nurodymus dėl saugos savo kalba.

LV – BRĪDINĀJUMS

Pirms šī izstrādājuma izsaiņošanas un uzstādīšanas izskatiet 1. pielikumā sniegtās drošības instrukcijas savā valodā.

MT - TWISSIJA

Jekk jogħġbok mur f'appendiċi 1 u aqra l-istruzzjonijiet tas-sigurtà fil-lingwa tiegħek qabel ma toħroġ dan il-prodott mill-ippakkjar u tinstallah.

NL - WAARSCHUWING

Ga naar appendix 1 en lees de veiligheidsinstructies in uw eigen taal, voordat u dit product uitpakt en installeert.

PL - OSTRZEŻENIE

Przed rozpakowaniem i zainstalowaniem tego produktu prosimy o zapoznanie się z Dodatkiem 1 i przeczytanie zaleceń dotyczących bezpieczeństwa w danym języku.

PT - ADVERTÊNCIA

Você deve retornar ao Anexo 1 e ler as instruções de segurança em seu idioma antes de desembalar e instalar este produto.

SP25M user's guide

www.renishaw.com

RO - AVERTISMENT

Înainte de a desface ambalajul și a instala acest produs, vă rugăm să căutați Anexa 1 și să citiți cu atenție instrucțiunile de siguranță, în limba română.

SK - VÝSTRAHA

Pred rozbalením a inštaláciou tohto produktu si pozrite prílohu 1 a prečítajte si bezpečnostné pokyny vo vašom jazyku.

SL - OPOZORILO

Preden izdelek vzamete iz embalaže in ga vgradite, odprite Prilogo 1 in preberite varnostna navodila v svojem jeziku.

SV - VARNING

Gå till bilaga 1 och läs säkerhetsinstruktionerna på ditt eget språk innan du packar upp och installerar denna produkt.

TW - 警告

在拆開和安裝本產品之前，請翻頁至附錄 1 閱讀母語的安全指示。

中文 — 警告

在拆包和安裝本產品之前，請翻到附錄1，閱讀中文版安全說明。

General safety recommendations



CAUTION: Before unpacking and installing the SP25M probe system, the user should carefully read the safety instructions below and ensure that they are followed at all times by all operators using the probe system. Use of controls or adjustments, or performance of procedures other than those specified herein may result in hazardous infra red radiation exposure. Operators must be trained in the use and application of the SP25M probe system and accompanying products, in the context of the machine it is fitted to, before being allowed to operate that machine.

NOTE: References are made below to features indicated [†] [‡] [◆] on the illustrations shown below. Please ensure that you clearly understand all safety instructions. Familiarisation with the SP25M system components, as shown in the following sections is recommended:



- System components overview
- Schematic diagram of probe system components
- Schematic diagram of FCR25 flexible change rack
- Schematic diagram of FCR25 TC flexible change rack

The SP25M probe system has mechanical overtravel protection provided in the probe +Z axis, by a fixed bumpstop. The machine control system must therefore be able to stop the motion of the machine, in this axis of the probe, before the bumpstop is reached. If this is not the case, the user must wear eye protection during operation in case of stylus breakage.

Care should be taken to ensure that the optical windows (indicated [◆]), located on both body and module, do not become damaged as they are made of glass and could cause injury.



CAUTION: Permanent magnets are used in some components of the SP25M system and associated products. It is important to keep them away from items which may be affected by magnetic fields, e.g. data storage systems, pacemakers and watches etc.

SP25M user's guide

www.renishaw.com

LED safety

The SP25M body contains embedded high power LED sources (indicated [†]) which emit invisible infra-red radiation. These sources are exposed when an SM25-# or TM25-20 module is not attached.

Removing the module breaks two sets of interlock switch contacts (indicated [‡]) to automatically switch off the LED power and assure user safety.

At suitable intervals, the interlock contacts should be inspected and checked to ensure that they are clean and free from airborne contamination such as dust, debris or swarf. In unlikely circumstances, such contamination could cause a short circuit of the pins and thus increase the risk of sending power to the LEDs, without a module being attached. Never connect conducting objects to, or between, the contacts. Follow the cleaning instructions in the [Maintenance](#) section.

Before inspecting, always remove the SP25M body from the probe head.

In the event of serious damage to, or a rupture of, any part of the SP25M body or scanning module outer casing, IMMEDIATELY disconnect power source, remove and do not attempt to re-use the parts, and contact your supplier for advice.

Safety illustrations

These diagrams show features, indicated [†] [‡] [◆] which are referred to within these safety recommendations.

SP25M probe body

End view showing kinematic joint to module

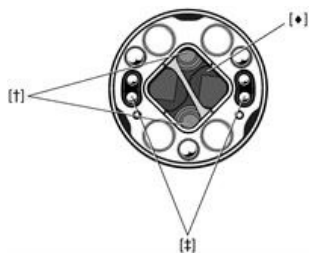

SP25M kinematic joint to module

SM25 scanning modules

End view showing kinematic joint to body



SP25M kinematic joint to body

SP25M user's guide

www.renishaw.com

SP25M introduction



NOTE: Before unpacking and installing the SP25M probe system, please read the safety information and ensure that they are followed at all times during system installation and operation.

This document is intended to provide help and guidance during initial installation, integration and subsequent use of the of the SP25M probe system. It is assumed that the system will be installed on a coordinate measuring machine using a controller system that has had full SP25M system integration in the form of a dedicated Renishaw controller or an AC3 (ISA bus) analogue interface PC card.

SP25M is a compact and versatile probe system that provides both scanning capability for form measurement or reverse engineering and touch-trigger probing for geometric size and position measurement.

The SP25M system provides highly accurate scanning measurement with stylus lengths from 20 mm to 400 mm as well as full TP20 touch-trigger probe module compatibility to suit a range of applications.

The SP25M system uses the Renishaw autojoint to enable repeatable mounting to the PH10M PLUS, PH10MQ PLUS and PH6M probe heads. Multiwired extension bar mounting of the SP25M system is also possible to extend the reach and enable more access to part features.

The range of SM25 scanning modules are designed to cover specific stylus length ranges whilst maintaining excellent accuracy performance. The system can be readily expanded to further increase the scanning range, allow TP20 touch-trigger measurement or utilise an automatic changer system.

Design principles of the SP25M system

The SP25M design features an optical transducer sensor system which is located within the SP25M probe body. The design also features a spring pivoting motion system which is located within the SM25 scanning modules.

Two infrared light emitting diodes (IREDs) mounted in the SP25M probe body project invisible infrared beams on to two mirrors mounted on the pivoting motion structure within the SM25 scanning module. The mirrors reflect the beam back to the SP25M probe body where their change in position is detected by two position sensitive devices (PSDs) when the stylus is deflected. The PSDs provide signal outputs in the three probe axes; P, Q and R.



NOTE: The SP25M probe system does not have a fixed rate, gain or resolution and the P, Q and R probe axis outputs are non-linear and non-orthogonal. These outputs are converted to X, Y and Z signals by the calibration routine. Renishaw offer support and advice on scanning calibration algorithms suited to SP25M.

The SM25 scanning modules are designed to provide an optimised level of accuracy and contact force over a specified stylus range. This minimises the reduction in performance seen in other types of scanning probes as the stylus length increases.

SP25M user's guide

www.renishaw.com

System components overview

System overview

The modular design of the SP25M system enables the flexibility for optimum configuration by the user. Please refer to the schematic diagrams showing the SP25M system components in the SP25M installation section of this document.

SP25M probe body

The SP25M probe body houses the optical transducer system and attaches to PH10M PLUS, PH10MQ PLUS or PH6M using a Renishaw autojoint connection.

SM25 scanning modules

There are five scanning modules in the SM25 range which enable accurate scanning measurements at different stylus lengths. SM25-1, SM25-2, SM25-3 and SM25-4 are recommended for use with linear stylus arrangements and SM25-5 is recommended for use with non-linear and star stylus arrangements.

SH25 stylus holders

The range of SH25 stylus holders enable accurate scanning measurements with effective stylus lengths ranging from 20 mm to 400 mm. SH25-1, SH25-2, SH25-3 and SH25-4 are recommended for use with linear stylus arrangements. SH25-2A, SH25-3A, SH25-4A and SH25-5 are recommended for use with non-linear and star stylus arrangements.

TM25-20 adaptor module

For rapid touch-trigger measurement, the TM25-20 adaptor module may be used which provides full compatibility with the whole range of TP20 touch-trigger probe modules.

SP25M user's guide

www.renishaw.com

FCR25 flexible change rack

Automated and repeatable changing of the SM25 scanning modules, SH25 stylus holders and TM25-20 is possible with FCR25. This triple port system is designed for mounting on the Renishaw MRS rail system.

FCR25-L3 and FCR25-L6 leg mounted flexible change racks

These variants of the FCR25 flexible change rack are designed to be mounted to the bed of the CMM with the integrated leg assembly.

FCR25 TC change rack

The FCR25 TC provides automated and repeatable changing of SM25 scanning modules whilst keeping the ports at the same operating temperature as the SP25M probe body. This ensures that there is no difference in temperature between the SP25M probe body and the SM25 scanning modules eliminating thermal variation and providing optimum metrology.

AC3 analogue interface PCB card

An ISA bus card to enable integration of the SP25M system with a CMM manufacturer's own controller.

SP25M user's guide

www.renishaw.com

Probe system components

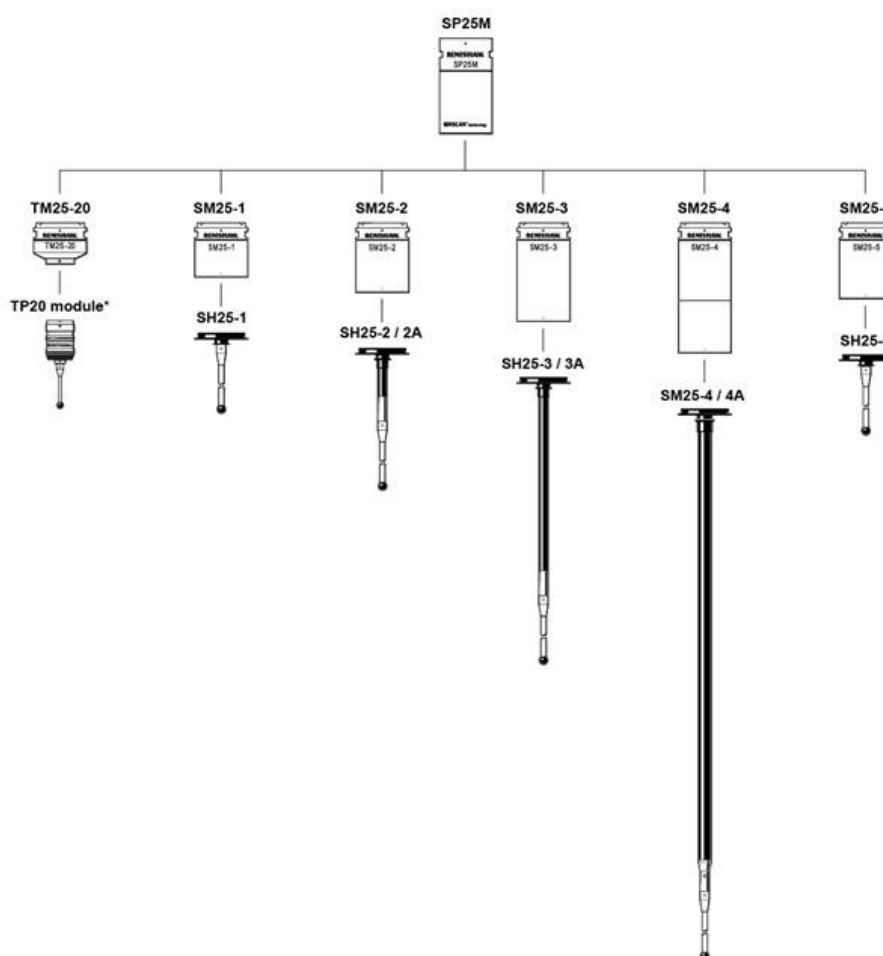

* Other variants exist

Scanning

The SM25 range of scanning modules are only compatible with the respective range of numbered stylus holders. Each scanning module is optimised to provide reliable and accurate measurement at a range of working lengths.

Touch-trigger probing

The TM25-20 adaptor module provides touch-trigger probing capability by utilising the full range of TP20 probe modules. Please visit www.renishaw.com/cmmguides for more information on the Renishaw TP20 touch-trigger probe system.

SP25M user's guide

www.renishaw.com

FCR25 flexible change rack system

FCR25 is a flexible change rack system that can be either mounted to an MRS rail or supplied with a standalone leg which can be fixed to the bed of the CMM. FCR25 provides automatic and repeatable changing of SP25M system scanning modules and stylus holders.

There are a number of port inserts that are required to interchange SH25 stylus holders and also TP20 modules. The PA25-SH port insert is used to allow the changing of the whole range of SH25 stylus holders, the PA25-20 should be used to allow TP20 modules to be changed using FCR25.

FCR25 can be fixed to an MRS rail in multiples, allowing more numbers of ports for housing and changing probe system components. There are three port and six port versions of the standalone FCR25 also available.

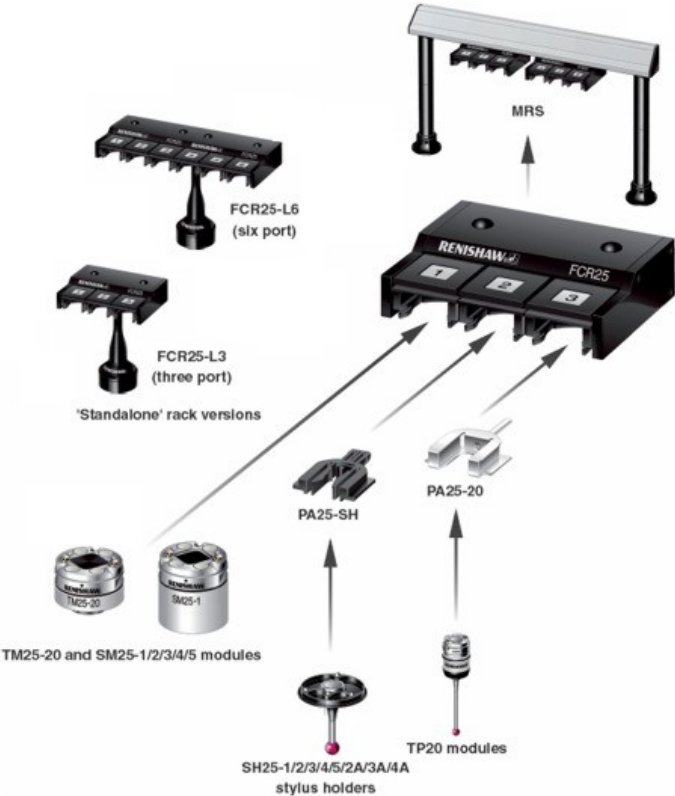

SP25M user's guide

www.renishaw.com

FCR25 TC temperature controlled flexible change rack

FCR25 TC is similar in function to the standard FCR25, the main difference being that temperature compensation is provided to optimise scanning module metrology performance.

No port inserts are compatible with FCR25 TC which means that only the SM25 scanning module components of the SP25M system can be changed using this rack.

FCR25 TC can be mounted directly to an MRS rail, there is also a three port standalone version that can be fixed directly to the bed on the CMM.



SP25M user's guide

www.renishaw.com

SP25M specification

Characteristic	Requirements
Probe attributes	Scanning with 3-axis measurement (X, Y, Z) Touch-trigger probing using TP20 modules
Measurement range	±0.5 mm deflection in all directions in all orientations
Overtravel range	
X, Y	±2 mm
+Z	1.7 mm
-Z	1.2 mm
Resolution	Capable of <0.1 µm
Spring rate	Nominally 0.6 N/mm - when using a module's shortest specified stylus Nominally 0.2 N/mm - when using a module's longest specified stylus
Probe dimensions	Ø25 mm × length dependant on module used
Weight	
SP25M body	65 g (2.29 oz)
SM25-1 scanning module	35 g (1.23 oz) (including SH25-1 but excluding stylus)
SM25-2 scanning module	40 g (1.41 oz) (including SH25-2 but excluding stylus)
SM25-3 scanning module	49 g (1.73 oz) (including SH25-3 but excluding stylus)
SM25-4 scanning module	71 g (2.50 oz) (including SH25-4 but excluding stylus)
SM25-5 scanning module	45 g (1.59 oz) (including SH25-5 but excluding stylus)
TM25-20 adaptor module	40 g (1.41 oz) (including TP20 STD module, but excluding stylus)
Effective stylus length range (Always observe the specified stylus range for the scanning module being used. Use Renishaw's M3 range of styli.)	
SM25-1 + SH25-1	EWL 20 mm - 50 mm (0.79 in - 1.97 in) using 20 mm - 50 mm stylus range
SM25-2 + SH25-2 / SH25-2A	EWL 50 mm - 105 mm (1.97 in - 4.14 in) using 20 mm - 75 mm stylus
SM25-3 + SH25-3 / SH25-3A	EWL 120 mm - 200 mm (4.73 in - 7.88 in) using 20 mm - 100 mm stylus
SM25-4 + SH25-4 / SH25-4A	EWL 220 mm - 400 mm (8.67 in - 15.75 in) using 20 mm - 200 mm stylus
SM25-5 + SH25-5	EWL 20 mm - 100 mm (0.79 in - 3.94 in) using 20 mm - 100 mm stylus

SP25M user's guide

www.renishaw.com

Mounting	Multiwired autojoint - compatible with PH10M PLUS / PH10MQ PLUS and PH6M probe heads, extension bars and ACR1 / ACR3 sensor changers
Crash protection	
±X, ±Y, -Z	Via break out of module or stylus holder
+Z	Via integral bump-stop design
Signal outputs	Non-linear and non-orthogonal analogue outputs - rate gain and resolution are not fixed
Signal outputs	Non-linear and non-orthogonal analogue outputs - rate gain and resolution are not fixed
Power supply	+12 V (±5%), -12 V (+10% / +8%), +5% (+10% / -13%) dc at probe
Probe calibration	Requires that non-linear, third order polynomial calibration method is used
Change rack options	
FCR25	Three port unit which mounts on MRS
FCR25-L3	Three port standalone rack version
FCR25-L6	Six port standalone rack version
FCR25 TC	Three port unit which mounts on MRS and warms scanning module
FCR25 TC-L3	Three port standalone rack version
Interface options	
UCC S3	
UCC2-2 systems	
OEM controller systems	AC3 interface card
	Interface for TP20 also required if applicable

SP25M user's guide

www.renishaw.com

SP25M dimensional information

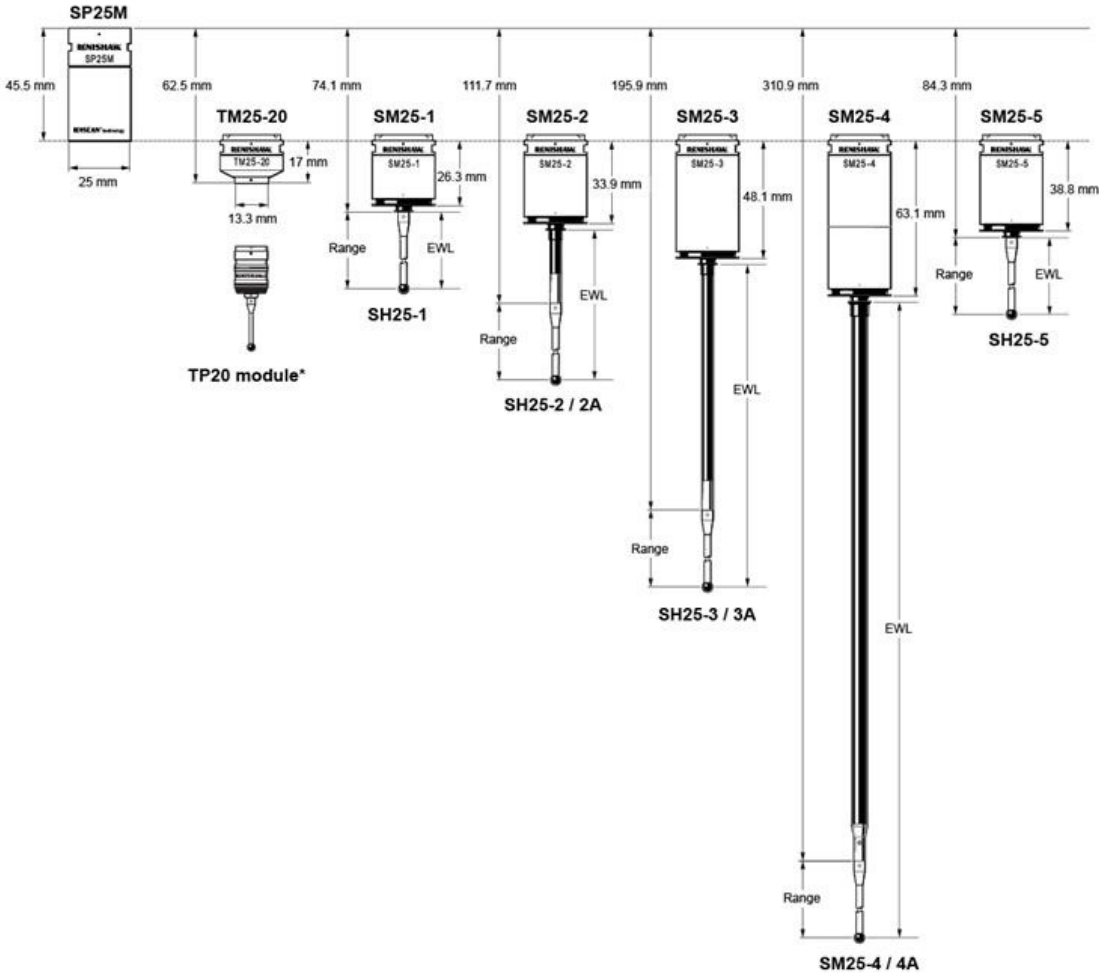

	SM25-1 SH25-1	SM25-2 SH25-2	SM25-2 SH25-2A	SM25-3 SH25-3	SM25-3 SH25-3A	SM25-4 SH25-4	SM25-4 SH25-4A	SM25-5 SH25-5
Range (mm)	20 - 50	20 - 75	20 - 75	20 - 100	20 - 100	20 - 200	20 - 200	20 - 100
EWL (mm)	20 - 50	50 - 105	50 - 105	120 - 200	120 - 200	220 - 400	220 - 400	20 - 100

FCR25 and FCR25 TC

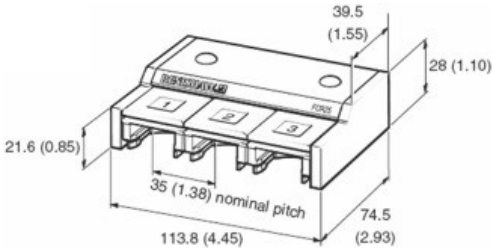

SP25M user's guide

www.renishaw.com

FCR25-L3 and FCR25 TC-L3 (three port)

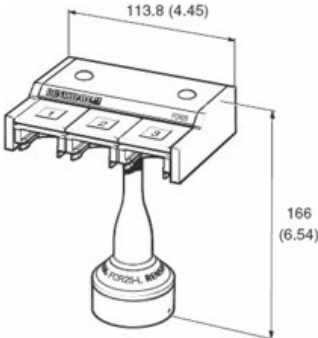

FCR25-L6 (six port)

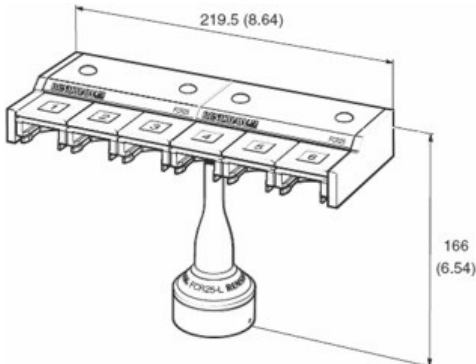

SP25M user's guide

www.renishaw.com

SP25M installation

i **NOTE:** All SP25M system components are identified with an engraved product name.

The front of each system component can be identified by the position of the Renishaw logo and the small alignment marks (where applicable).

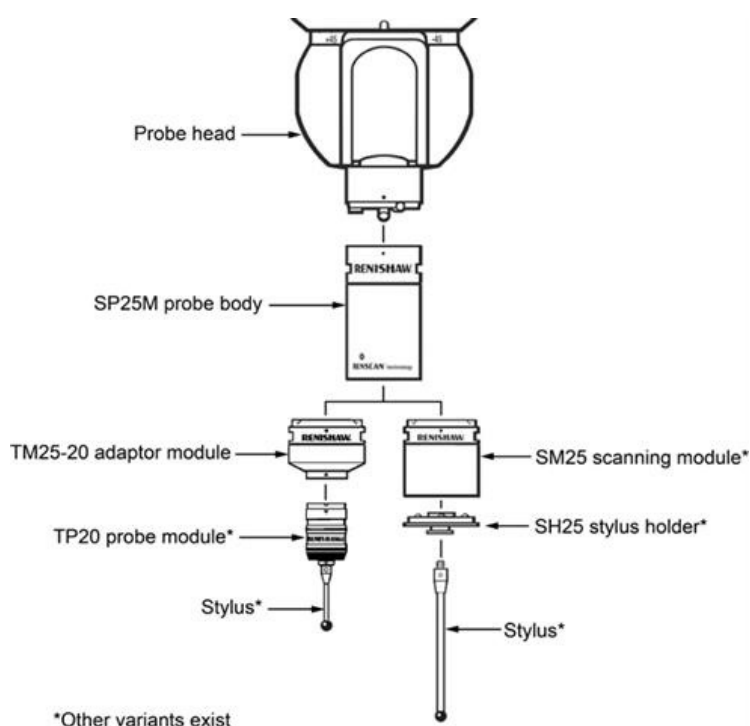

Observe the kinematic mating faces between the SM25 scanning modules and each respective SH25 stylus holder. Each stylus holder kinematic face features four balls, three of which are arranged in a triangular formation which form one half of the kinematic joint between the stylus holder and each respective module. The fourth ball is positioned so that only the scanning module and respective stylus holder can be fitted and used together.

When installing and using the various system elements it is essential that the kinematic joints are clean and free from contaminants. Please refer to the maintenance pages for further cleaning instructions.

Renishaw probes and associated systems are precision tools used for obtaining precise measurements and must therefore be treated with care. The SP25M probe body and scanning modules are liable to irreparable damage if dropped or mistreated.

SP25M user's guide

www.renishaw.com

Attaching the SP25M probe body to the probe head

i **NOTE:** To ensure optimum metrology performance it is recommended that following any probe change (either manual or automatic), the probe head is unlocked and locked.

The SP25M probe body can be mounted on a PH10M PLUS, PH10MQ PLUS or PH6M probe head by means of the Renishaw autojoint. Locking and unlocking the autojoint is carried out manually using the S10 autojoint key or automatically using a Renishaw autochange rack system (ACR1 or ACR3). In both cases, the connection eliminates the need for probe requalification (recalibration) after changing tools.



1. Ensure the slot at the rear of the SP25M body is horizontal and lying across the probe axis. This is the unlocked position.
2. Carefully position the SP25M probe body underneath the probe head ensuring that the dots on both the body and head are aligned.
3. Connect and hold the probe body and probe head together.
4. Insert the S10 autojoint key into the slot on the back of the probe body and turn clockwise until it locks tight. If intending to autochange the probe body in an ACR1 or ACR3 rack then the slot should be rotated five degrees anticlockwise from the fully clockwise position.
5. Unlock and lock the probe head before using the probe.

To remove the SP25M probe body from the probe head, reverse the steps detailed above.

SP25M user's guide

www.renishaw.com

Attaching an SM25 or TM25-20 module to the SP25M probe body

i **NOTE:** To ensure optimum metrology performance it is recommended that following any probe change (either manual or automatic), the probe head is unlocked and locked.

The SM25 scanning modules and TM25-20 adaptor module connect with a kinematic coupling to the bottom face of the SP25M probe body. This connection eliminates the need for probe requalification (recalibration) after changing tools. The change can be performed manually or automatically using an FCR25 flexible change rack.

If an FCR25 TC temperature controlled rack is not being used, it is recommended that for optimum performance the SM25 scanning module should be allowed 20 minutes to reach operating temperature. Using a module which has not been given time to reach operating temperature could affect the results given by the system. This is due to the thermal drift of the module before it reaches optimum operating temperature.



1. Align the front of the probe body and module.
2. Tilt the module so that the front of both components begin to connect.
3. Allow the front of the module to connect to the probe body.
4. Tilt the module backwards and allow the magnets to carefully connect the kinematic joint between the two components.
5. Unlock and lock the probe head before using the probe.

To remove the module, hold and carefully tilt to break the kinematic joint.

SP25M user's guide

www.renishaw.com

Attaching an SH25 stylus holder to an SM25 scanning module

The range of SH25 stylus holders have a kinematic coupling that connects to each respective SM25 scanning module. This connection eliminates the need for probe requalification (recalibration) after changing tools. The change can be performed manually or automatically using an FCR25 flexible change rack (highly recommended for optimum performance).

Each stylus holder is only compatible with its respective scanning module. Incorrect combinations are prevented by the unique position of the orientation ball in the stylus holder kinematic joint. All SH25 stylus holders use the Renishaw M3 range of styli.



Manually attaching an SH25 stylus holder to an SM25 scanning module

1. Align the front of the stylus holder and probe module.
2. Slowly connect the stylus holder to the bottom of the probe module. Allow the magnets to carefully connect the kinematic joint between the stylus holder and module.
3. Gently rotate the stylus holder to ensure a correct connection.

To remove the stylus holder, hold and carefully tilt to break the kinematic joint.

Attaching a stylus to a stylus holder

1. Ensure the stylus holder is not attached to the probe module.
2. Always stay within the recommended stylus capability range for each stylus holder.
3. Avoid touching the kinematic face of the stylus holder.
4. When tightening the stylus ensure that the correct M3 stylus tool is used.

SP25M user's guide

www.renishaw.com

Attaching a TP20 module to the TM25-20 adaptor module

The full range of TP20 modules can be mounted to the TM25-20 adaptor module with a kinematic joint that eliminates the need for probe requalification (recalibration) after changing tools. The change can be performed manually or automatically using an FCR25 or FCR25 TC flexible change rack (highly recommended for optimum performance).

More information about the Renishaw range of TP20 touch-trigger modules can be found in the TP20 probe system installation and user's guide (part number: H-1000-5008) which can be downloaded in PDF format from the Renishaw website www.renishaw.com/cmmguides.



1. Align the front of the TP20 module and the TM25-20 adaptor module using their alignment marks.
2. Slowly connect the TP20 to the bottom of the TM25-20. Allow the magnets to carefully connect the kinematic joint between both components.

To remove the TP20 module, hold and carefully tilt to break the kinematic joint.

SP25M user's guide

www.renishaw.com

FCR25 flexible change rack

The FCR25 flexible change rack is a triple port unit that provides unmatched flexibility when rapid and automatic tool changing is required. FCR25 is a passive rack design meaning no electrical connection is required. During a change cycle, it is still necessary however to inhibit probe signals.



NOTE: Renishaw strongly recommends the use of FCR25 to ensure optimum performance when changing elements of the SP25M probe system.

FCR25 racks can be mounted in multiples along a Renishaw MRS rail which enables rack port configurations in multiples of three. Any port in an FCR25 rack can be used to change all of the following system elements:

- The whole range of SM25 scanning modules
- The TM25-20 adaptor module
- The whole range of SH25 stylus holders (using a PA25-SH port adaptor insert)
- The whole range of TP20 modules (using a PA25-20 port adaptor insert)

FCR25 TC temperature controlled flexible change rack

The FCR25 TC flexible change rack is a triple port unit that provides unmatched flexibility when rapid and automatic tool changing is required. The FCR25 TC rack is powered by a standard 24 V mains supply that is supplied with the unit.

The integrated temperature control functionality heats the rack ports to elevate any housed modules to the same temperature as a powered SP25M probe. Although FCR25 TC is a powered rack, it is still necessary to inhibit probe signals during a change cycle.

NOTE: Renishaw strongly recommends the use of FCR25 TC to ensure optimum performance when changing the scanning modules of an SP25M system. To change any other components of the SP25M system, a standard FCR25 should be used.

In installations where ultimate accuracy is required, it is recommended that the system is left in a powered state.

FCR25 TC racks can be mounted in multiples along a Renishaw MRS rail in conjunction with standard FCR25 units which enable rack port configurations in multiples of three. FCR25 TC can only be used for scanning modules. FCR25 should be used for all other system elements.

General FCR25 and FCR25 TC installation information

The information in this document that describes the mounting and aligning of the FCR25 and FCR25 TC racks assumes that the MRS rail is positioned along the X-axis of the CMM with the probe head positioned at A0 B0 during a change routine. If the MRS2 rack is mounted along the Y-axis of the CMM, it will be necessary to transpose all references to axis, motion and orientation.

It is also assumed that the MRS rail has been correctly installed on the CMM as defined in the MRS installation and user's guide which can be downloaded in PDF format from the Renishaw website www.renishaw.com/cmmguides.

When two or more FCR25 racks are used together, it is possible to remove the adjoining plastic end caps to enable an unbroken line of ports. Carefully remove the end caps to reveal a series of machined lug features. These are used to align the adjoining FCR25 racks. This is not possible with FCR25 TC racks.

Mounting an FCR25 and FCR25 TC to an MRS rail system

i **NOTE:** The procedure described below has proven to be simple, quick and effective to complete. It is still recommended however that the user practices the routines to become familiar and competent with the process.

1. The FCR25 and FCR25 TC is mounted to the underside of the MRS rail and clamped in position by using two T-nuts.
2. Mount the FCR25 or FCR25 TC in the desired position along the MRS rail and hand-tighten the screws.
3. Align the FCR25 or FCR25 TC to the X-axis of the CMM by taking two points [P1] and [P2] as shown below. Adjust the position so that a maximum run out of 0.25 mm is achieved between [P1] and [P2].
4. Securely tighten the screws, the docking positions for the system elements can now be set.

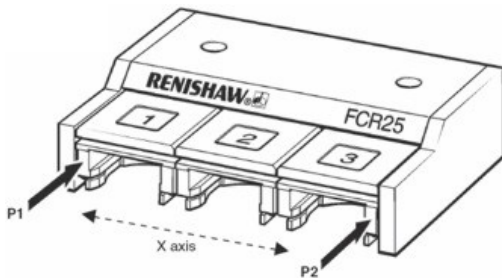

SP25M user's guide

www.renishaw.com

Mounting an FCR25 or FCR25 TC leg mounted rack to the CMM table

1. Place the location piece over the desired hole on the CMM table and secure using the bolt supplied.
2. Position the FCR25 or FCR25 TC leg mounted rack over the location piece and loosely tighten the fixing screw at the rear of the leg assembly.
3. Align the rack to the CMM's axes by taking two points at [P1] and [P2] as shown. Adjust the rotational alignment of the rack until a maximum run out of 0.25 mm for FCR25-L3 and FCR25 TC-L3 or 0.5 mm for FCR26-L6 is achieved.
4. Securely tighten the fixing screw, the docking positions for the system elements can now be set.

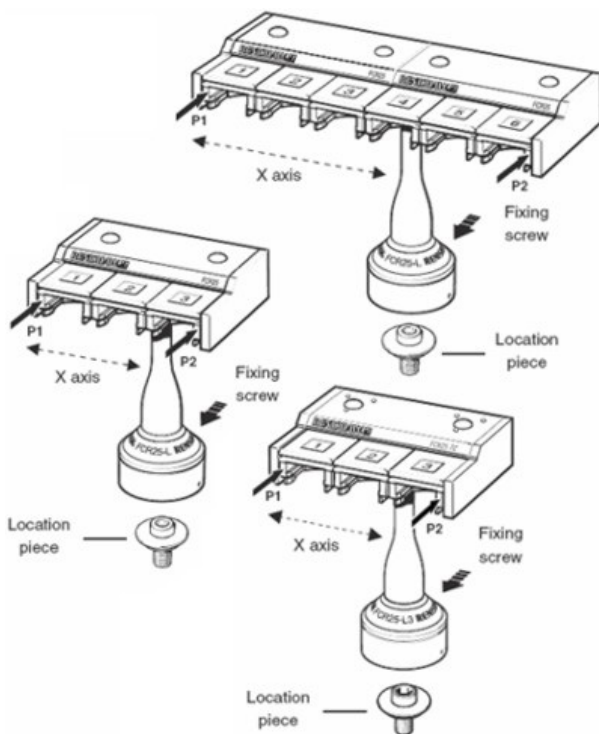

SP25M user's guide

www.renishaw.com

System interconnection diagram

A typical interconnection diagram using the AC3 analogue interface card is shown below. For more detail, please refer to the SP25M installation and integration guide (part number: H-1000-7541) which can be downloaded in PDF format from the Renishaw website www.renishaw.com/cmmguides.

CAUTION: Ensure that the appropriate switch settings are selected on the AC3 card. These settings can be found on the AC3 analogue interface PC card installation webpage.

The SP25M probe connects to the AC3 card through the probe head and through a standard Renishaw multiwire cable. This cable connects directly to the probe head via a micro-D and terminates in a 15-way high-density D which connects directly to the rear panel of the AC3.

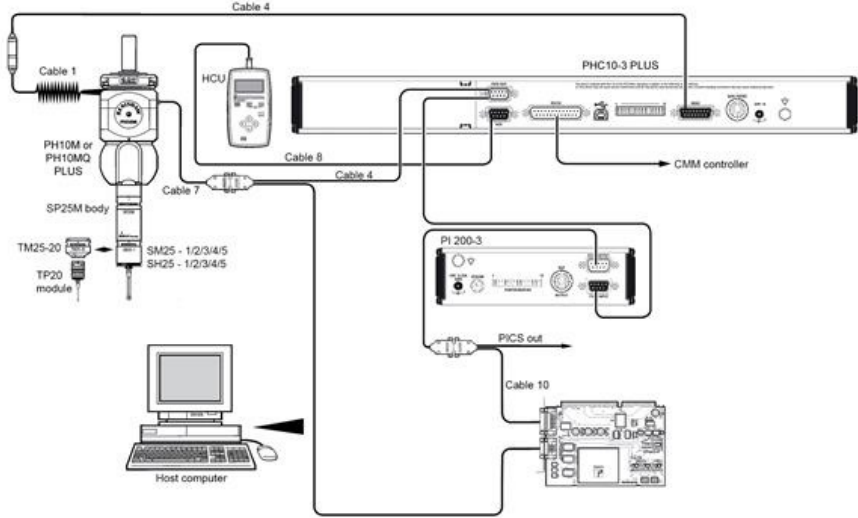

SP25M calibration

The SP25M probe requires calibration before it can give accurate positional data.



NOTE: As the analogue outputs from SP25M are non-linear and non-orthogonal, a third order polymer non-linear calibration method should always be used for optimum accuracy.

At the nominal free stylus position the probe outputs will not be zero. These zero offsets are determined and saved as part of the non-linear calibration.

For maximum probe performance in scanning mode, Renishaw recommends that the SP25M is qualified (calibrated) using a third order, polynomial, non-linear calibration method using two different deflections such as 0.2 mm and 0.5 mm. It is very important that during scanning operation the CMM controller maintains a deflection that is less than the higher of these qualification deflections.

SP25M user's guide

www.renishaw.com

SP25M operation

Modes of operation

The SP25M is an analogue output measurement probe and may be used in a variety of ways. Principally, these will be either as a single point measurement probe or as a profile measurement / digitising probe.

Scanning mode

SP25M can be used as a continuous deflection analogue contact scanning probe for profile measurement or for surface digitising purposes. In this case the CMM controller must respond to the deflections of the probe in real time to maintain surface contact.

Touch-trigger mode

SP25M can be used as a traditional touch-trigger probe using all seven modules in the TP20 probe range. Operating characteristics and instructions are given in the TP20 system installation and user's guide (Renishaw part number: H-1000-5008) which can be downloaded in PDF format from the Renishaw website www.renishaw.com/cmmguides.

Reorientation

The SP25M probe may be used in different orientations when mounted on a Renishaw PH10M PLUS or PH10MQ PLUS motorised head. The design has been optimised to ensure the working range of the probe can be achieved in all orientations.

SP25M user's guide

www.renishaw.com

SP25M technical terms

Return to zero

The probe has a nominal absolute centre position where the functions of stylus configuration and probe orientation cause it to rest. Because of small amounts of internal friction, when the probe is displaced from this zero point, the stylus will not return to exactly the same point on the scale and the axis deflection readings will show a different value.

This characteristic of probe performance is called RETURN TO ZERO and is a feature of all analogue probes and is not a source of error as the scale system continues to monitor position. Rather, it is merely a factor which must be taken into account when designing control software for using the probe. It can be given a value which represents the diameter of a sphere around the nominal zero position within which the probe will return to reset after any displacement.

SP25M has a return to zero value of less than 5 microns after a deflection of 0.5 mm (typically 1 μm). It is important to take this into account as it affects the minimum amount of deflection necessary before the stylus is considered to be in contact with the surface. Because the stylus can return to a value other than the nominal zero, the CMM must recognise the fact that the range of rest positions of the stylus must not cause machine motion, as the stylus is not necessarily in contact with a surface even though it is 'deflected'.

Minimum probe deflection

The CMM controller should set a parameter for minimum probe deflection, above the return to zero value. The stylus should only be considered to be in contact with a surface while the deflection exceeds this threshold.

Maximum probe deflection

A spherical operating range of ± 0.5 mm (± 0.02 in) deflection in all directions in all orientations is guaranteed provided that the stylus carrying recommendations are adhered to. The mechanical travel of the scanning module is greater than the transducer operating range. If this range is exceeded the axis signals (P, Q, R) become invalid.

Probe over range signal

This signal is asserted by the probe to indicate that the transducer operating range has been exceeded. The CMM controller must then take appropriate recovery action.

SP25M user's guide

www.renishaw.com

Using the FCR25 and FCR25 TC

It is assumed that the FCR25 and or the FCR25 TC has been installed on the MRS rack system as described in the '[Mounting an FCR25 and FCR25 TC to an MRS rail system](#)' pages of this document.

It is also assumed that all SP25M system components have been set up as described in the installation pages of this document. Please refer to the installation pages for clarification of the various datum positions used in this document.



NOTE: It is necessary to inhibit the probe signal through software during the change routine.

SP25M user's guide

www.renishaw.com

FCR25 TC warm up time

When an FCR25 TC is used with SM25 scanning modules, all components must reach the correct operating temperature for optimum metrology performance.

There are two methods to ensure that the FCR25 TC and the SM25 scanning modules have reached the correct operating temperature prior to use:

1. Power the FCR25 TC rack and leave for 60 minutes to allow optimum operating temperature to be reached. After 60 minutes, fit the SM25 scanning modules in the rack and leave for a further 20 minutes to allow the optimum operating temperature to be reached.
2. Fit the SM25 scanning modules in the FCR25 TC rack and then connect the rack power. Leave the rack and scanning modules for 60 minutes to reach the optimum operating temperature.

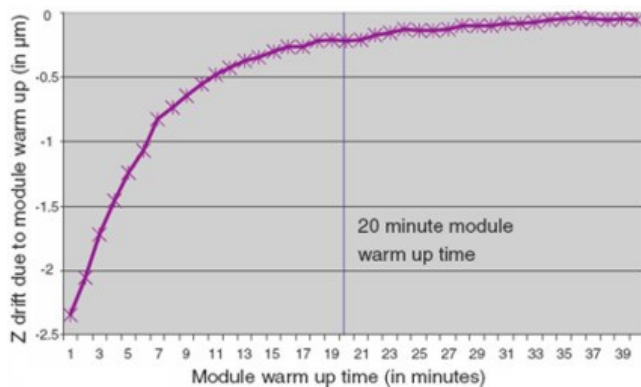

The examples below explain the warm up periods that may be required in certain situations:

1. **Warm SP25M probe and cold SM25 scanning modules from a standard FCR25**
Assuming a warm SP25M probe body is fitted to the CMM and a cold module is picked up from a standard FCR25, the time taken to reach optimum temperature is 20 minutes.
2. **Warm SP25M probe and cold SM25 scanning modules from a warm FCR25 TC**
Assuming a warm SP25M probe body is fitted to the CMM and the FCR25 TC is warm, a cold SM25 scanning module would need to be left in the rack for 20 minutes to reach optimum operating temperature.
3. **Cold SP25M probe with a warm SM25 scanning modules from a warm FCR25 TC.**
If a cold SP25M probe is picked up from an ACR3 rack and a warm SM25 scanning module is picked up from a warm FCR25 TC rack, drift will be less than 1 µm after three minutes.

SP25M user's guide

www.renishaw.com

Establishing a docking position for SM25 and TM25-20 modules

This section describes how to manually position the probe body and module to define the module docking position of the desired port. This process requires very fine movements under CMM joystick control and care must be taken to avoid any collisions of the probe body, module and port.

Eye protection should be worn during this procedure and a good level of lighting is recommended to ensure no collisions occur. This procedure is the same when using the FCR25 or the FCR25 TC rack.

1. Latch the port lids open using the triangular plastic inserts provided.
2. Place the SM25 or TM25-20 module in the desired port.

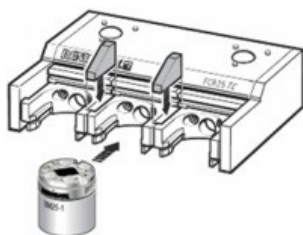

Steps 1 and 2 - latching port lids open and placing module into desired port (n)

3. Ensure the probe head is orientated at an A0 B0 position.
4. Mount the SP25M probe body to the probe head.
5. Inhibit the probe signal through software.



NOTE: Great care is required during the next part of this procedure as there is very little clearance between the probe body and module and the rack port. Carefully observe all movement to ensure that no collisions occur.

6. Using CMM joystick control, position the probe head and SP25M probe body directly above the probe module that has been placed in the rack port.



Step 6 onwards - watch for clearances to ensure no collision between parts

SP25M user's guide

www.renishaw.com

7. Slowly lower the probe body towards the probe module ensuring that the XY position of the probe body does not collide with the port.

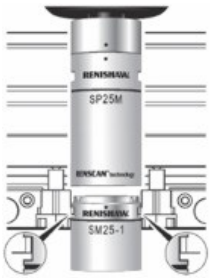

Step 6 and 7 - moving to approximate XY position then refining to ensure good alignment between body and module

8. Continue to lower the probe body towards the probe module until the magnetic attraction between the kinematic joint makes the module move towards the probe body. The module should move slightly towards the kinematic joint of the probe body without tilting (indicating good XY alignment). If any tilting occurs when the module moves towards the probe body (indicating poor XY alignment) then the probe head and body should be repositioned and the process should be repeated.



Step 8 - slowly move body downward in Z axis until module jumps straight upwards due to magnetic attraction

9. Slowly lower the probe body on to the module, stop any movement when the LED on the probe head illuminates. This indicates that an electrical connection is made.



Step 9 - slowly move body downward in Z axis - STOP immediately when the probe head LED is lit

SP25M user's guide

www.renishaw.com

Step 9 - slowly move body downward in Z axis - STOP immediately when the probe head LED is lit

10. Offset the CMM using a DCC movement of 0.75 mm in a -Z direction at a speed of 5 mm/s.
11. Create a datum coordinate system for the module docking position of the port at the following position: [dat_MOD_port(n)].
12. Slowly move the connected probe head, body and module assembly in a -Y direction clear of the port.
13. Remove the module and place back in the port.
14. Enable the probe signal through software (probe signal now armed).
15. Repeat steps 2 to 13 above for all other modules required.

SP25M user's guide

www.renishaw.com

Establishing a docking position for SH25 stylus holders

This section describes how to establish the docking position for the SH25 stylus holder. The docking position is defined by taking a series of measurements using the stylus holder setting piece (SHSP). The SHSP is a dummy stylus holder with a short cylindrical stem of a qualified length and diameter. This provides known constant values to accurately calculate the port docking position.

Eye protection should be worn during this procedure and a good level of lighting is recommended to ensure no collisions occur.

It is necessary to turn off tip radius compensation when taking points using the SHSP because it is not calibrated. However, a suitable tip qualification (calibration) should be applied as detailed below.

Before taking points using the SHSP, a probe tip qualification should be applied that has previously been defined for a suitable configuration of SM25 scanning modules, SH25 stylus holder and stylus length. This configuration should be the shortest length possible, for example SM25-1, SH25-1 and a 21 mm stylus. In instances where SM25-3, SH25-3 and a 21 mm stylus is the only configuration available, it is recommended that the approach speed when taking points is restricted to 3 mm/s or less.

If using a threshold deflection method to measure points, the threshold deflection should be set to 0.050 mm.



CAUTION: Failure to follow the above recommendations could lead to severe damage of the SM25 scanning module when taking points with the SHSP.

1. Latch the port lids open using the triangular plastic inserts provided
2. The desired port should be fitted with a PA25-SH port adapter insert. Orientate the PA25-SH as shown in the image below. Slide the port adapter into the port ensuring that the side lugs of the adapter locate in the slots at either side of the port. Push the PA25-SH port adapter in to the port until it clips securely in to the port. Check that the adapter is fitted correctly and that there is no misalignment.

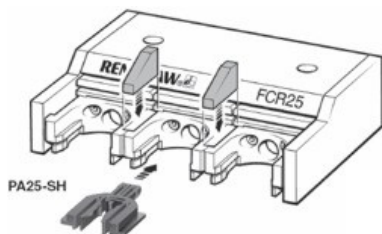

Steps 1 and 2 - latching port lids open and placing PA25-SH into desired port(n)

SP25M user's guide

www.renishaw.com

3. Ensure the probe head is orientated at an A0 B0 position.
4. Inhibit the probe signal through software.
5. Mount the desired SM25 scanning module to the SP25M probe body.
6. Mount the SHSP to the probe module as described above.



Step 6 - the SHSP is mounted to the SM25 scanning module

7. Enable the probe signal through software (probe signal now armed).
8. Turn off tip radius compensation.
9. Measure a point on the top of the port [P1], offset the point by -20 mm in the Z-axis.

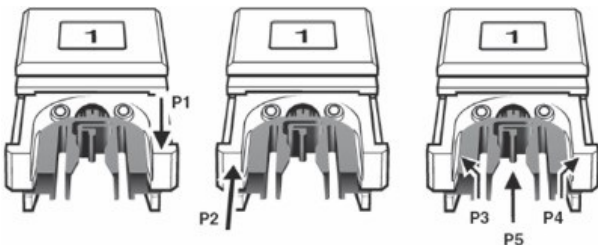

Step 9 - take a point on port top surface

Step 10 - take a point on port front side face

Step 11 - taking 2 points on port inside rails

10. Measure a point on the front lip of the port [P2], offset the point by + 16 mm in the Y-axis.
11. Measure two points [P3 and P4] on the inside rails of the port and construct a point [P5] between them.
12. Create a datum coordinate system for the stylus holder docking position of the port. This will be at the X position of P5, the Y position of P2 and the Z position of P1 – [dat_SH_port(n)].

SP25M user's guide

www.renishaw.com

Establishing a docking position for TP20 modules

This section describes how to establish the docking position for the combination of a TM25-20, a TP20 module and a stylus.

1. Latch the port lids open using the triangular plastic inserts provided
2. The desired port should be fitted with a PA25-20 port adapter insert. Orientate the PA25-20 as shown in the image below. Slide the port adapter into the port ensuring that the side lugs of the adapter locate in the slots at either side of the port. Push the PA25-20 port adapter in to the port and use a 2.5 mm hex key to tighten. Check that the adapter is fitted correctly and that there is no misalignment.

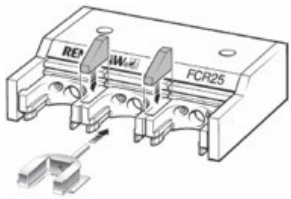

Steps 1 and 2 - latching port lids open and placing PA25-20 into desired port(n)

3. Ensure the probe head is orientated at an A0 B0 position.
4. Inhibit the probe signal through software.
5. Mount the desired combination of TM25-20, TP20 module and stylus to the probe body.
6. Enable the probe signal through software (probe signal now armed).
7. Qualify (calibrate) the stylus tip on the reference sphere.

SP25M user's guide

www.renishaw.com

8. Measure four points on the top surface of the PA25-20 to create a plane [PLN1]. Translate this plane to the Z-axis and offset this plane by [Z - length of stylus - 21.25 mm] and set the Z-axis origin to this plane.

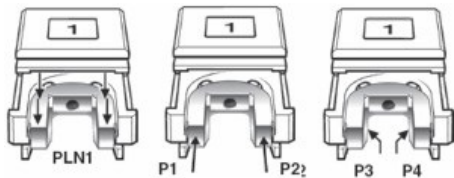

Step 8 - take four points on top of PA25-20

Step 9 - take two points on front side faces of PA25-20

Step 10 - take two points on port inside rails of PA25-20

9. Measure two points [P1 and P2] on the front faces of the PA25-20. Construct a line [L1] between these points, rotate this line to the X-axis, offset the line by [Y + 8.75 mm] and origin the Y-axis position of the line.

10. Measure two points [P3 and P4] on the inside rails of each side of the PA25-20. Construct a point [P5] between them.

11. Create a datum coordinate system [dat_TP20_port(n)] for the TP20 module docking position of the port. This will be at the position of [P5], the Y position of [L1] and the Z position of [PLN1].

12. Repeat steps 1 to 13 above for all other module combinations required.

SP25M user's guide

www.renishaw.com

Pick up routines

Pick up routine - SM25 scanning modules and TM25-20 adaptor module

Move description	X-axis (mm)*	Y-axis (mm)*	Z-axis (mm)*
Clearance position	[dat_MOD_port(n)]	[dat_MOD_port(n)] - 30 mm	[dat_MOD_port(n)] + 8 mm
Enter port	no change	[dat_MOD_port(n)]	no change
Towards module	no change	no change	[dat_MOD_port(n)] + 3 mm
Attach module(s)	no change	no change	[dat_MOD_port(n)]
Exit port	no change	[dat_MOD_port(n)] - 30 mm	no change



NOTE: To ensure optimum metrology performance it is recommended that following any module change the probe head is unlocked and then relocked.

Pick up routine - SH25 stylus holders

Move description	X-axis (mm)*	Y-axis (mm)*	Z-axis (mm)*
Clearance position	[dat_SH_port(n)]	[dat_SH_port(n)] - 30 mm	[dat_SH_port(n)] + 8 mm
Enter port	no change	[dat_SH_port(n)]	no change
Towards stylus holder(s)	no change	[dat_SH_port(n)]	[dat_SH_port(n)] + 3 mm
Attach stylus holder(s)	no change	[dat_SH_port(n)]	[dat_SH_port(n)]
Exit port	no change	[dat_MOD_port(n)] - 30 mm	no change

Pick up routine - TP20 module

Move description	X-axis (mm)*	Y-axis (mm)*	Z-axis (mm)*
Clearance position	[dat_TP20_port(n)]	[dat_TP20_port(n)] - 30 mm	** [dat_TP20_port(n)] + 6 mm
Enter port	no change	[dat_TP20_port(n)]	no change
Towards TP20 module	no change	[dat_TP20_port(n)]	**[dat_MOD_port(n)] + 3 mm
Attach TP20 module(s)	no change	[dat_TP20_port(n)]	**[dat_MOD_port(n)]
Exit port	no change	[dat_TP20_port(n)] - 30 mm	no change

* Coordinates assume aligned with Y-axis as per [FCR25 mounting instructions](#)

** Calculate nominal 'Z' docking position according to the stylus length used (see calculation formula in section [Establishing the docking position for SH25 stylus holders](#)).

SP25M user's guide

www.renishaw.com

Put down routines

Put down routine - SM25 scanning modules and TM25-20 adaptor module

Move description	X-axis (mm)*	Y-axis (mm)*	Z-axis (mm)*
Clearance position	[dat_MOD_port(n)]	[dat_MOD_port(n)] - 30 mm	[dat_MOD_port(n)]
Enter port	no change	[dat_MOD_port(n)]	no change
Detach module	no change	no change	[dat_MOD_port(n)] + 3 mm
Clear of module	no change	no change	[dat_MOD_port(n)] + 8 mm
Exit port	no change	[dat_MOD_port(n)] - 30 mm	no change



NOTE: To ensure optimum metrology performance it is recommended that following any module change the probe head is unlocked and then relocked.

Put down routine - SH25 stylus holders

Move description	X-axis (mm)*	Y-axis (mm)*	Z-axis (mm)*
Clearance position	[dat_SH_port(n)]	[dat_SH_port(n)] - 30 mm	[dat_SH_port(n)]
Enter port	no change	[dat_SH_port(n)]	no change
Detach stylus holder(s)	no change	no change	[dat_SH_port(n)] + 3 mm
Clear of module	no change	no change	[dat_SH_port(n)] + 8 mm
Exit port	no change	[dat_SH_port(n)] - 30 mm	no change

Put down routine - TP20 module

Move description	X-axis (mm)*	Y-axis (mm)*	Z-axis (mm)*
Clearance position	[dat_TP20_port(n)]	[dat_TP20_port(n)] - 30 mm	** [dat_TP20_port(n)]
Enter port	no change	[dat_TP20_port(n)]	no change
Detach TP20 module	no change	no change	**[dat_MOD_port(n)] + 3 mm
Clear of module(s)	no change	no change	** [dat_MOD_port(n)] + 8 mm
Exit port	no change	[dat_TP20_port(n)] - 30 mm	no change

* Coordinates assume aligned with Y-axis as per [FCR25 mounting instructions](#)

** Calculate nominal 'Z' docking position according to the stylus length used (see calculation formula in section [Establishing the docking position for SH25 stylus holders](#)).

Speed of motion during a change routine



NOTE: When obtaining or returning an SM25 scanning module, a TM25-20 adaptor module or an SH25 stylus holder, the motion speed over the 3 mm distance where the kinematic joint is made and broken should be restricted to a maximum of 5 mm/s. All other moves may be made at up to a maximum of 30 mm/s.

SP25M straight stylus carrying capability and performance guidelines

SP25M gives exceptional scanning performance over the entire range of stylus lengths. This is achieved by using a dedicated set of scanning modules, SM25-1, SM25-2, SM25-3, SM25-4 and SM25-5. Each module is optimised to carry a specific stylus range whilst maintaining a low contact force band and maximised sensor performance.

This design approach has enabled SP25M to successfully counter the loss of scanning system performance traditionally encountered as stylus length increases. It is therefore important to adhere to the stylus carrying recommendations given.

Use of the Renishaw range of M3 styli and accessories is recommended. This range includes several longer styli with carbon fibre stems for exceptional performance as well as kits specifically suited to each of the scanning modules.

SP25M user's guide

www.renishaw.com

SP25M minimum and maximum stylus carry capability diagram

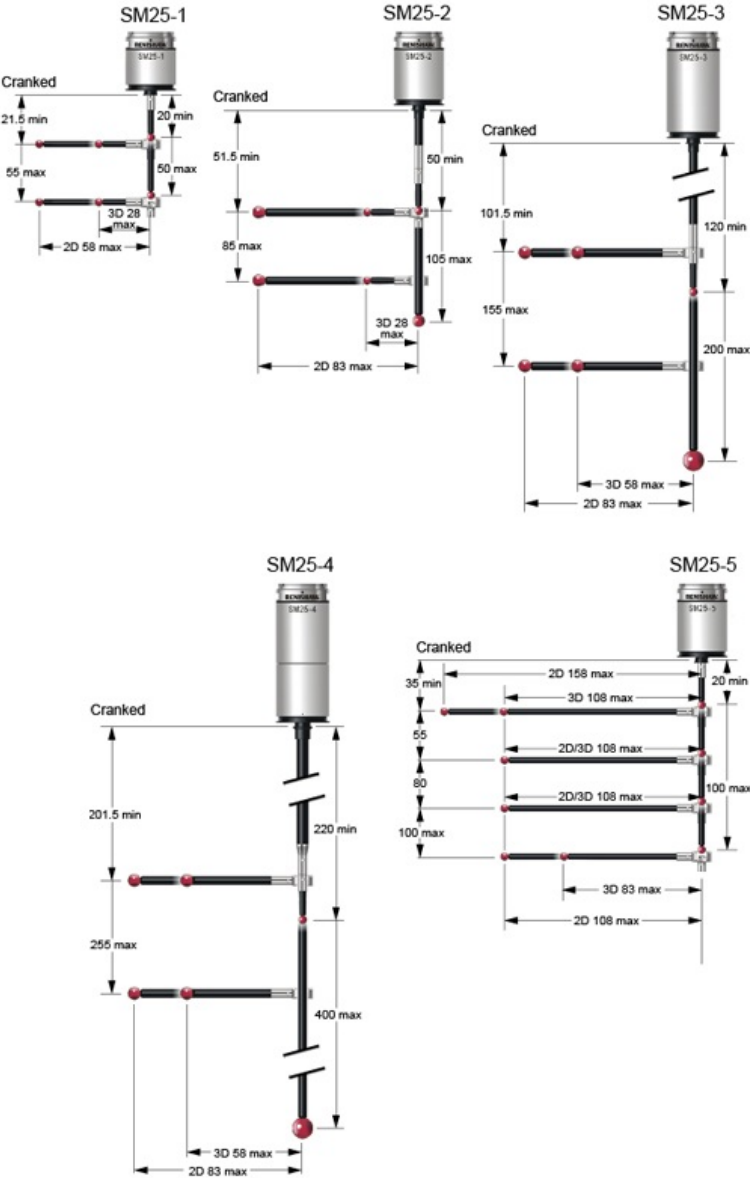

SP25M user's guide

www.renishaw.com

SP25M straight styli carrying capability

SP25M - straight stylus carrying capability

Module / stylus holder	SM25-1 / SH25-1	SM25-2 / SH25-2	SM25-3 / SH25-3	SM25-4 / SH25-4	SM25-5 / SH25-5
Effective stylus reach (by using these stylus lengths)	20 mm - 50 mm (20 mm - 50 mm)	50 mm - 105 mm (20 mm - 75 mm)	120 mm - 200 mm (20 mm - 100 mm)	220 mm - 400 mm (20 mm - 200 mm)	20 mm - 100 mm (20 mm - 100 mm)
Maximum permissible stylus length vs (mass)	20 mm (7 g)* 30 mm (10 g) 40 mm (13 g) 50 mm (14 g)*	20 mm (3 g)* 40 mm (8 g) 50 mm (10 g) 75 mm (11 g)*	20 mm (9 g)* 50 mm (10 g) 75 mm (15 g) 100 mm (15 g)*	20 mm (7 g)* 100 mm (8 g) 150 mm (9 g) 200 mm (15 g)*	20 mm (10 g) 50 mm (10 g) 75 mm (11 g) 100 mm (12 g)
Maximum operating stylus tip deflection for above in any orientation	0.5 mm	0.5 mm	0.5 mm	0.5 mm	0.3 mm

* Representative test results for these configurations is shown in [straight styli performance](#).

SP25M - SH25-A - straight stylus carrying capability

Module / stylus holder	SM25-2 / SH25-2A	SM25-3 / SH25-3A	SM25-4 / SH25-4A
Effective stylus reach (by using these stylus lengths)	50 mm - 105 mm (20 mm - 75 mm)	120 mm - 200 mm (20 mm - 100 mm)	220 mm - 400 mm (20 mm - 200 mm)
Maximum permissible stylus length vs (mass)	20 mm (2.5 g) 40 mm (7.5 g) 50 mm (9.5 g) 75 mm (10.5 g)	20 mm (8 g) 50 mm (9 g) 75 mm (10 g) 100 mm (10 g)	20 mm (7.5 g) 100 mm (8.5 g) 150 mm (9 g) 200 mm (9 g)
Maximum operating stylus tip deflection for above in any orientation	0.5 mm	0.5 mm	0.5 mm

i NOTE: SM25-1 and SM25-5 do not require an SH25-A as these stylus holders do not have carbon fibre stems.

SP25M user's guide

www.renishaw.com

SP25M cranked stylus carrying capability for typical stylus combinations

As well as straight styli, SP25M has the ability to carry cranked styli when using the standard range of SM25 scanning modules. For optimum metrology and when larger offsets are required, it is recommended that the SH25-3A, SH25-4A and SH25-5A modules are used.

For SH25-1, SH25-2 and SH25-2A it is mandatory that a 20 mm or longer stylus extension is used between the SH25 stylus holder and the crank centre to give the correct crank down distance from the stylus holder to the crank centre.

When using SH25-3, SH25-4, SH25-3A and SH25-4A, the crank centre may either be mounted directly to the stylus holder or to a stylus extension between the stylus holder and the crank centre.

For SM25-1, SM25-2, SM25-3 and SM25-4, a straight downward pointing stylus can be added to the crank centre to continue the projection down from the stylus holder. This is providing that the maximum overall stylus length and mass does not exceed the recommended limits for the particular module being used.

For 3D scanning with SM25-1 and SM25-2, the maximum crank out distance is 28 mm and is measured from the cranked (non straight) stylus tip to the centre of the crank centre. For 3D scanning with SM25-3 and SM25-4, the maximum crank out distance is 58 mm.

Multiple cranked styli may be used providing the overall mass of the crank centre and stylus does not exceed the recommended limits for the particular module being used.

Please refer to the Renishaw stylus catalogue for the full range of cranked and star stylus configurations available. It is recommended that a one piece star stylus is used whenever possible to minimise the mass of the assembly. Greater flexibility is offered however by configuring a crank centre with one or more cranked styli.

Module / stylus holder	'Crank down' distance using an extension* between the stylus holder and the crank centre	3D scanning Maximum 'crank out' distance when measured to tip of crank (star) stylus	2D scanning and point taking Maximum 'crank out' distance when measured to tip of crank (star) stylus	Maximum 'down' stylus (same as 'effective stylus reach' - see straight styli)	Maximum permissible mass of crank (star) centre plus all styli	Maximum operating stylus tip deflection for above in any orientation
SM25-1 / SH25-1	25 mm**	28 mm**	58 mm**	50 mm	9 g***	0.4 mm
SM25-1 / SH25-1	55 mm**	28 mm**	58 mm**	50 mm	9 g****	0.4 mm
SM25-2 / SH25-2	55 mm	28 mm	83 mm	105 mm	6 g***	0.4 mm
SM25-2 / SH25-2	85 mm	28 mm	83 mm	105 mm	7 g****	0.4 mm

SP25M user's guide

www.renishaw.com

Module / stylus holder	'Crank down' distance using an extension* between the stylus holder and the crank centre	3D scanning Maximum 'crank out' distance when measured to tip of crank (star) stylus	2D scanning and point taking Maximum 'crank out' distance when measured to tip of crank (star) stylus	Maximum 'down' stylus (same as 'effective stylus reach' - see straight styli)	Maximum permissible mass of crank (star) centre plus all styli	Maximum operating stylus tip deflection for above in any orientation
SM25-2A / SH25-2A	55 mm**	28 mm**	83 mm**	105 mm	6 g***	0.4 mm
SM25-2A / SH25-2A	85 mm**	28 mm**	83 mm**	105 mm	7 g****	0.4 mm
SM25-3 / SH25-3	105 mm	58 mm	83 mm	200 mm	13 g	0.4 mm
SM25-3 / SH25-3	125 mm	58 mm	83 mm	200 mm	12 g***	0.4 mm
SM25-3 / SH25-3	155 mm	58 mm	83 mm	200 mm	11 g****	0.4 mm
SM25-3A / SH25-3A	105 mm	58 mm	83 mm	200 mm	12 g	0.4 mm
SM25-3A / SH25-3A	125 mm	58 mm	83 mm	200 mm	11 g***	0.4 mm
SM25-3A / SH25-3A	155 mm**	58 mm	83 mm**	200 mm	10 g****	0.4 mm
SM25-4 / SH25-4	205 mm	58 mm	83 mm	400 mm	11 g	0.4 mm
SM25-4 / SH25-4	225 mm	58 mm	83 mm	400 mm	10 g***	0.4 mm

SP25M user's guide

www.renishaw.com

Module / stylus holder	'Crank down' distance using an extension* between the stylus holder and the crank centre	3D scanning Maximum 'crank out' distance when measured to tip of crank (star) stylus	2D scanning and point taking Maximum 'crank out' distance when measured to tip of crank (star) stylus	Maximum 'down' stylus (same as 'effective stylus reach' - see straight styli)	Maximum permissible mass of crank (star) centre plus all styli	Maximum operating stylus tip deflection for above in any orientation
SM25-4 / SH25-4	255 mm	58 mm	83 mm	400 mm	8 g****	0.4 mm
SM25-4A / SH25-4A	205 mm	58 mm	83 mm	400 mm	11 g	0.4 mm
SM25-4A / SH25-4A	225 mm**	58 mm	83 mm**	400 mm	10 g***	0.4 mm
SM25-4A / SH25-4A	255 mm	58 mm	83 mm	400 mm	8 g****	0.4 mm
SM25-5 / SH25-5	35 mm	108 mm	158 mm	100 mm	11 g*****	0.3 mm
SM25-5 / SH25-5	55 mm	108 mm	108 mm	100 mm	10 g*****	0.3 mm
SM25-5 / SH25-5	80 mm	108 mm	108 mm	100 mm	11 g*****	0.3 mm
SM25-5 / SH25-5	100 mm	83 mm	108 mm	100 mm	12 g*****	0.3 mm

* For example, use part number M-5000-3592 (20 mm long × M3 stainless steel extension)

** Representative test results for these configurations is shown in [SH25 stylus holder range metrology performance](#)

*** This excludes the mass of the 20 mm extension

**** This excludes the mass of the 50 mm extension

***** This includes the crank down extension mass

SP25M user's guide

www.renishaw.com

SP25M stylus performance guidelines

ISO 10360-2 test

Span (μm)

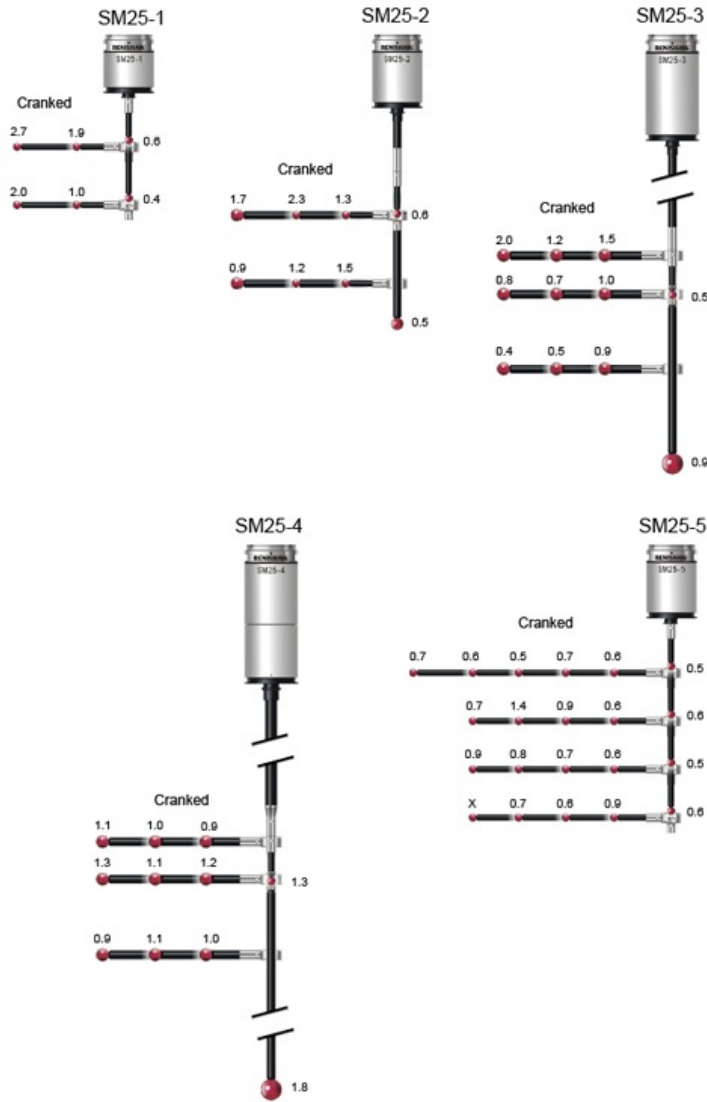

SP25M user's guide

www.renishaw.com

SS - stainless steel, CER - ceramic, GF - carbon fibre

ISO 10360-2 test - straight styli

Scanning module	Effective stylus reach	Actual M3 stylus used: Length / tip Ø/ stem material	Radius error	RMS	SPAN
SM25-1	21 mm	21 mm / Ø4 mm / SS	-0.09 µm	0.15 µm	0.6 µm
SM25-1	50 mm	50 mm / Ø5 mm / CER	-0.09 µm	0.11 µm	0.4 µm
SM25-2	51 mm	21 mm / Ø4 mm / SS	-0.4 µm	0.15 µm	0.6 µm
SM25-2	105 mm	75 mm / Ø6 mm / GF	-0.26 µm	0.13 µm	0.5 µm
SM25-3	121 mm	21 mm / Ø4 mm / SS	-0.44 µm	0.14 µm	0.5 µm
SM25-3	200 mm	100 mm / Ø6 mm / GF	-0.19 µm	0.24 µm	0.9 µm
SM25-4	221 mm	21 mm / Ø5 mm / SS	0.1 µm	0.34 µm	1.3 µm
SM25-4	400 mm	200 mm / Ø8 mm / GF	0.4 µm	0.42 µm	1.8 µm
SM25-5	21 mm	21 mm / Ø4 mm / SS	-0.4 µm	0.12 µm	0.5 µm
SM25-5	105 mm	100 mm / Ø5 mm / CF	-0.37 µm	0.20 µm	0.68 µm

SP25M user's guide

www.renishaw.com

ISO 10360-2 test - cranked styli

Scanning module	Crank configuration	Actual M3 stylus used: Length / tip Ø / stem material (mounted to crank centre)	Radius error	RMS	SPAN
SM25-1	25 mm 'down' 28 mm 'out'	21 mm / Ø4 mm / SS	0.1 µm	0.48 µm	1.9 µm
SM25-1	25 mm 'down' 57.5 mm 'out'	50 mm / Ø5 mm / CER	-0.04 µm	0.56 µm	2.7 µm
SM25-1	55 mm 'down' 28 mm 'out'	21 mm / Ø4 mm / SS	0.15 µm	0.21 µm	1 µm
SM25-1	55 mm 'down' 57.5 mm 'out'	50 mm / Ø5 mm / CER	0.03 µm	0.34 µm	2 µm
SM25-2	55 mm 'down' 28 mm 'out'	21 mm / Ø4 mm / SS	0.54 µm	0.38 µm	1.3 µm
SM25-2	55 mm 'down' 57.5 mm 'out'	50 mm / Ø5 mm / CER	0.19 µm	0.61 µm	2.3 µm
SM25-2	55 mm 'down' 83 mm 'out'	75 mm / Ø6 mm / GF	0.07 µm	0.53 µm	1.7 µm
SM25-2	85 mm 'down' 28 mm 'out'	21 mm / Ø4 mm / SS	0.35 µm	0.34 µm	1.5 µm
SM25-2	85 mm 'down' 57.5 mm 'out'	50 mm / Ø5 mm / CER	0.05 µm	0.23 µm	1.2 µm
SM25-2	85 mm 'down' 83 mm 'out'	75 mm / Ø6 mm / GF	0.09 µm	0.25 µm	0.9 µm
SM25-3	105 mm 'down' 28 mm 'out'	21 mm / Ø4 mm / SS	0.3 µm	0.41 µm	1.5 µm
SM25-3	105 mm 'down' 57.5 mm 'out'	50 mm / Ø5 mm / CER	-0.23 µm	0.31 µm	1.2 µm
SM25-3	105 mm 'down' 83 mm 'out'	75 mm / Ø6 mm / GF	0.66 µm	0.56 µm	2 µm
SM25-3	125 mm 'down' 28 mm 'out'	21 mm / Ø4 mm / SS	0.14 µm	0.28 µm	1 µm
SM25-3	125 mm 'down' 57.5 mm 'out'	50 mm / Ø5 mm / CER	0.12 µm	0.16 µm	0.7 µm
SM25-3	125 mm 'down' 83 mm 'out'	75 mm / Ø6 mm / GF	0 µm	0.22 µm	0.8 µm
SM25-3	155 mm 'down' 28 mm 'out'	21 mm / Ø4 mm / SS	0.28 µm	0.25 µm	0.9 µm

SP25M user's guide

www.renishaw.com

	mm 'out'				
SM25-3	155 mm 'down' 57.5 mm 'out'	50 mm / Ø5 mm / CER	0.06 µm	0.15 µm	0.5 µm
SM25-3	155 mm 'down' 83 mm 'out'	75 mm / Ø6 mm / GF	0.04 µm	0.1 µm	0.4 µm
SM25-4	205 mm 'down' 28 mm 'out'	21 mm / Ø4 mm / SS	0.01 µm	0.24 µm	0.9 µm
SM25-4	205 mm 'down' 57.5 mm 'out'	50 mm / Ø5 mm / CER	0.19 µm	0.21 µm	1 µm
SM25-4	205 mm 'down' 83 mm 'out'	75 mm / Ø6 mm / GF	-0.11 µm	0.28 µm	1.1 µm
SM25-4	225 mm 'down' 28 mm 'out'	21 mm / Ø4 mm / SS	0.01 µm	0.21 µm	1.2 µm
SM25-4	225 mm 'down' 57.5 mm 'out'	50 mm / Ø5 mm / CER	0.18 µm	0.29 µm	1.1 µm
SM25-4	225 mm 'down' 83 mm 'out'	75 mm / Ø6 mm / GF	0.05 µm	0.3 µm	1.3 µm
SM25-4	255 mm 'down' 28 mm 'out'	21 mm / Ø4 mm / SS	-0.07 µm	0.25 µm	1 µm
SM25-4	255 mm 'down' 57.5 mm 'out'	50 mm / Ø5 mm / CER	0.1 µm	0.34 µm	1.1 µm
SM25-4	255 mm 'down' 83 mm 'out'	75 mm / Ø6 mm / GF	-0.1 µm	0.21 µm	0.9 µm

SP25M user's guide

www.renishaw.com

Test setup criteria

Test site	Renishaw UK
Styli used	Renishaw's M3 stylus range
CMM specification	$U^3 = 0.48 \mu\text{m} + L / 1000$
CMM controller	Renishaw's UCC2
Probe calibration	Renishaw's third order polynomial calibration method
Data filter used	Harmonic simple cut off order = 60 UPR (undulations per revolution)
Artefacts used	Ø25 mm (nom) calibration sphere (for the ISO 10360 Part 2 / Part 4 tests) Ø50 mm (nom) ring gauge (for the ring gauge scan tests)
Scanning speed	5 mm/s (for the ISO 10360 Part 4 and ring gauge scan tests)
Touch speed	5 mm/s (for the ISO 10360 Part 2 tests)
Back off speed	1 mm/s (for the ISO 10360 Part 2 tests)
Bi-directional scans	<p>The effect of probe misalignment and contact friction will result in radius changes with scanning direction if a suitable calibration procedure is not used.</p> <p>Mechanical hysteresis within a probe mechanism is best demonstrated by a bi-directional scan.</p> <p>Therefore, Renishaw have decided to take the high integrity approach of quoting ring gauge metrology using bi-directional scan data to demonstrate the performance of the Renishaw probe and calibration method.</p>

SP25M user's guide

www.renishaw.com

ISO 10360-4 test

Filtered MPE_{THN} (60 UPR μm)

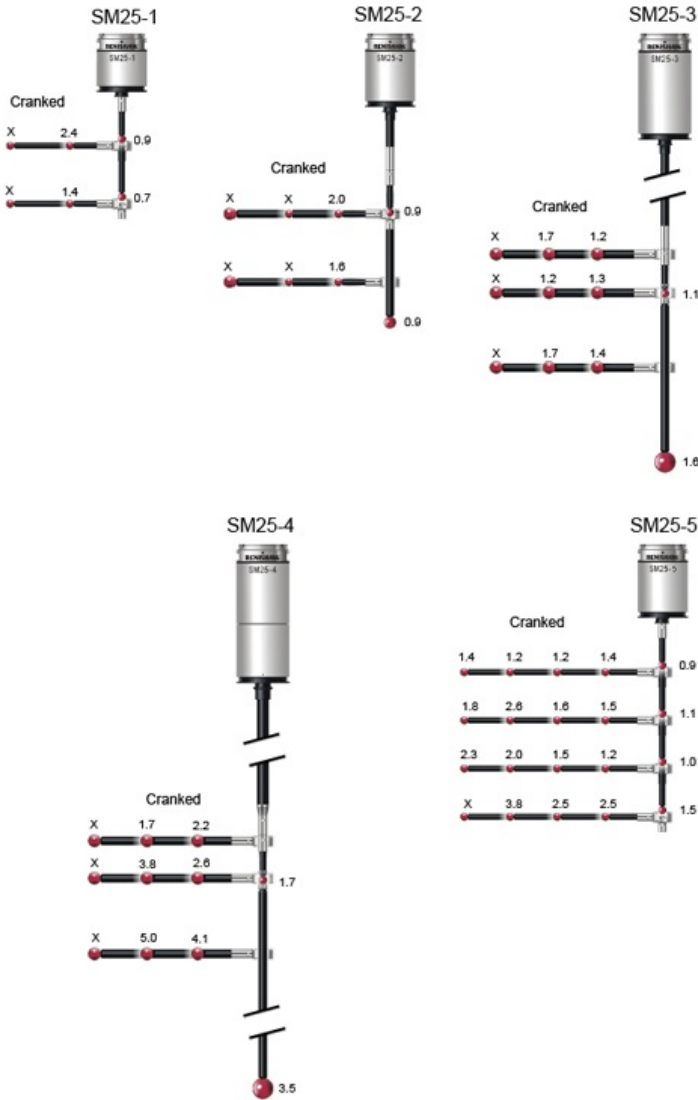

SP25M user's guide

www.renishaw.com

SS - stainless steel, CER - ceramic, GF - carbon fibre

ISO 10360-4 test - straight styli

Scanning module	Effective stylus reach	Actual M3 stylus used: Length / tip Ø / stem material	ISO MPE _{THN} data raw	ISO MPE _{THN} data filtered	ISO Diff data raw	ISO Diff data filtered	Stylus tip deflection	Time taken
SM25-1	21 mm	21 mm / Ø4 mm / SS	1.4 µm	0.9 µm	0.8 µm	0.5 µm	0.2 mm	1' 07"
SM25-1	50 mm	50 mm / Ø5 mm / CER	1.5 µm	0.7 µm	0.8 µm	0.4 µm	0.2 mm	1' 08"
SM25-2	51 mm	21 mm / Ø4 mm / SS	1.5 µm	0.9 µm	0.8 µm	0.5 µm	0.2 mm	1' 07"
SM25-2	105 mm	75 mm / Ø6 mm / GF	1.6 µm	0.9 µm	0.9 µm	0.5 µm	0.2 mm	1' 14"
SM25-3	121 mm	21 mm / Ø4 mm / SS	1.9 µm	1.1 µm	1.0 µm	0.6 µm	0.2 mm	1' 07"
SM25-3	200 mm	100 mm / Ø6 mm / GF	3.2 µm	1.6 µm	2.1 µm	1.0 µm	0.2 mm	1' 16"
SM25-4	221 mm	21 mm / Ø5 mm / SS	2.8 µm	1.7 µm	1.5 µm	0.9 µm	0.2 mm	1' 14"
SM25-4	400 mm	200 mm / Ø8 mm / GF	6.4 µm	3.5 µm	3.7 µm	0.9 µm	0.2 mm	1' 17"
SM25-5	21 mm	21 mm / Ø4 mm / SS	2.1 µm	0.9 µm	1.1 µm	0.5 µm	0.2 mm	1' 08"
SM25-5	105 mm	100 mm / Ø5 mm / CF	2.8 µm	1.5 µm	1.5 µm	1.0 µm	0.2 mm	1' 14"

SP25M user's guide

www.renishaw.com

ISO 10360-4 - cranked styli

Scanning module	Crank configuration	Actual M3 stylus used: Length / tip Ø / stem material (mounted to crank centre)	ISO MPE _{THN} data raw	ISO MPE _{THN} data filtered	ISO Diff data raw	ISO Diff data filtered	Stylus tip deflection	Time taken
SM25-1	25 mm 'down' 28 mm 'out'	21 mm / Ø4 mm / SS	3.1 µm	2.4 µm	1.7 µm	1.2 µm	0.2 mm	1' 11"
SM25-1	55 mm 'down' 28 mm 'out'	21 mm / Ø4 mm / SS	4.8 µm	1.4 µm	2.4 µm	0.8 µm	0.2 mm	1' 09"
SM25-2	55 mm 'down' 28 mm 'out'	21 mm / Ø4 mm / SS	2.5 µm	2 µm	1.5 µm	1.3 µm	0.2 mm	1' 09"
SM25-2	85 mm 'down' 28 mm 'out'	21 mm / Ø4 mm / SS	2.8 µm	1.6 µm	1.7 µm	1 µm	0.2 mm	1' 08"
SM25-3	105 mm 'down' 28 mm 'out'	21 mm / Ø4 mm / SS	1.8 µm	1.2 µm	1.2 µm	0.8 µm	0.2 mm	1' 12"
SM25-3	105 mm 'down' 57.5 mm 'out'	50 mm / Ø5 mm / CER	2.3 µm	1.7 µm	1.3 µm	1 µm	0.2 mm	1' 12"
SM25-3	125 mm 'down' 28 mm 'out'	21 mm / Ø4 mm / SS	2.1 µm	1.3 µm	1.2 µm	0.8 µm	0.2 mm	1' 12"
SM25-3	125 mm 'down' 57.5 mm 'out'	50 mm / Ø5 mm / CER	2.2 µm	1.2 µm	1.3 µm	0.7 µm	0.2 mm	1' 11"
SM25-3	155 mm 'down' 28mm 'out'	21 mm / Ø4 mm / SS	2.7 µm	1.4 µm	1.9 µm	1.2 µm	0.35 mm	1' 16"
SM25-3	155 mm 'down' 57.5 mm 'out'	50 mm / Ø5 mm / CER	2.6 µm	1.7 µm	1.7 µm	1.1 µm	0.35 mm	1' 16"
SM25-4	205 mm 'down' 28 mm 'out'	21 mm / Ø4 mm / SS	3 µm	2.2 µm	1.7 µm	1.3 µm	0.2 mm	1' 11"

SP25M user's guide

www.renishaw.com

SM25-4	205 mm 'down' 57.5 mm 'out'	50 mm / Ø5 mm / CER	2.6 µm	1.7 µm	1.8 µm	1.2 µm	0.2 mm	1' 17"
SM25-4	225 mm 'down' 28 mm 'out'	21 mm / Ø4 mm / SS	3.2 µm	2.6 µm	2.0 µm	1.9 µm	0.2 mm	1' 16"
SM25-4	225 mm 'down' 57.5 mm 'out'	50 mm / Ø5 mm / CER	4.6 µm	3.8 µm	3.5 µm	3.2 µm	0.2 mm	1' 25"
SM25-4	255 mm 'down' 28 mm 'out'	21 mm / Ø4 mm / SS	5 µm	4.1 µm	3 µm	2.6 µm	0.2 mm	1' 10"
SM25-4	255 mm 'down' 57.5 mm 'out'	50 mm / Ø5 mm / CER	8.3 µm	5 µm	4.9 µm	2.7 µm	0.2 mm	1' 10"

SP25M user's guide

www.renishaw.com

Test setup criteria

Test site	Renishaw UK
Styli used	Renishaw's M3 stylus range
CMM specification	$U^3 = 0.48 \mu\text{m} + L / 1000$
CMM controller	Renishaw's UCC2
Probe calibration	Renishaw's third order polynomial calibration method
Data filter used	Harmonic simple cut off order = 60 UPR (undulations per revolution)
Artefacts used	Ø25 mm (nom) calibration sphere (for the ISO 10360 Part 2 / Part 4 tests) Ø50 mm (nom) ring gauge (for the ring gauge scan tests)
Scanning speed	5 mm/s (for the ISO 10360 Part 4 and ring gauge scan tests)
Touch speed	5 mm/s (for the ISO 10360 Part 2 tests)
Back off speed	1 mm/s (for the ISO 10360 Part 2 tests)
Bi-directional scans	<p>The effect of probe misalignment and contact friction will result in radius changes with scanning direction if a suitable calibration procedure is not used.</p> <p>Mechanical hysteresis within a probe mechanism is best demonstrated by a bi-directional scan.</p> <p>Therefore, Renishaw have decided to take the high integrity approach of quoting ring gauge metrology using bi-directional scan data to demonstrate the performance of the Renishaw probe and calibration method.</p>

SP25M user's guide

www.renishaw.com

Bi-directional ring gauge

Filtered span (60 UPR μm)

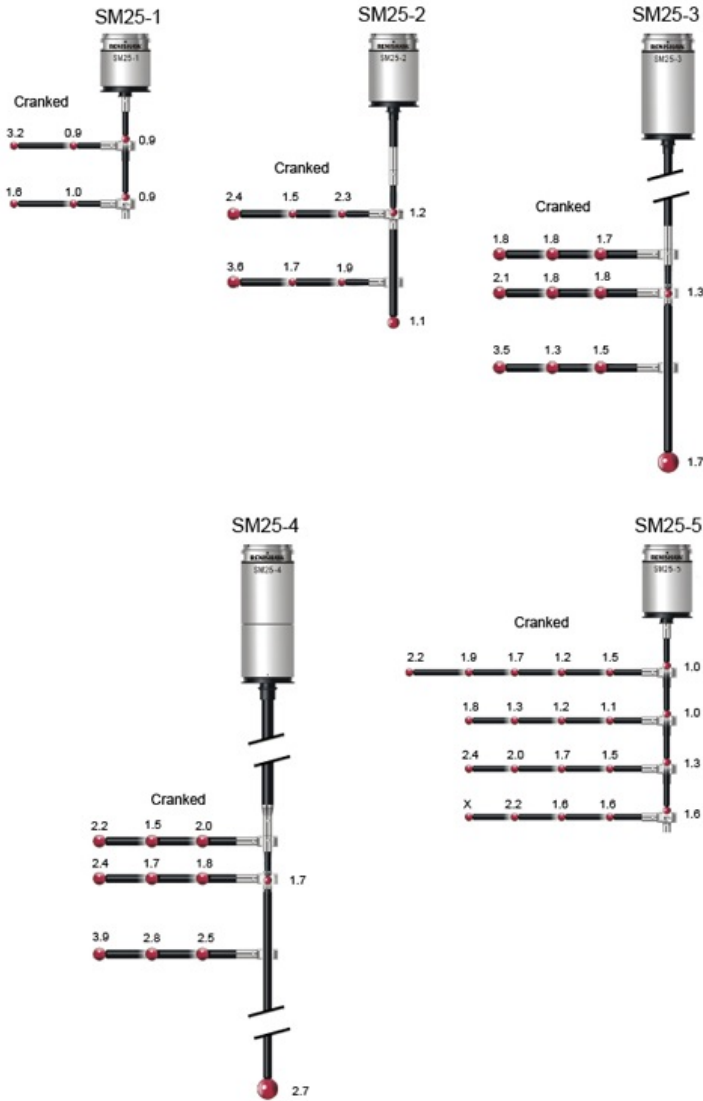

SP25M user's guide

www.renishaw.com

SS - stainless steel, CER - ceramic, GF - carbon fibre

Bi-directional ring gauge scan test - straight styli

Scanning module	Effective stylus reach	Actual M3 stylus used: Length / tip Ø / stem material	RMS data raw	RMS data filtered	SPAN data raw	SPAN data filtered	Stylus tip deflection	Raw data pts
SM25-1	21 mm	21 mm / Ø4 mm / SS	0.23 µm	0.19 µm	1.5 µm	0.9 µm	0.35 mm	2857
SM25-1	50 mm	50 mm / Ø5 mm / CER	0.24 µm	0.17 µm	1.5 µm	0.9 µm	0.2 mm	2794
SM25-2	51 mm	21 mm / Ø4 mm / SS	0.24 µm	0.21 µm	1.6 µm	1.2 µm	0.2 mm	2858
SM25-2	105 mm	75 mm / Ø6 mm / GF	0.24 µm	0.18 µm	2.0 µm	1.1 µm	0.2 mm	2609
SM25-3	121 mm	21 mm / Ø4 mm / SS	0.38 µm	0.20 µm	2.2 µm	1.3 µm	0.2 mm	2857
SM25-3	200 mm	100 mm / Ø6 mm / GF	0.38 µm	0.27 µm	4.1 µm	1.7 µm	0.2 mm	2484
SM25-4	221 mm	21 mm / Ø5 mm / SS	0.40 µm	0.30 µm	3.0 µm	1.7 µm	0.2 mm	2462
SM25-4	400 mm	200 mm / Ø8 mm / GF	0.80 µm	0.50 µm	5.7 µm	2.7 µm	0.2 mm	2388
SM25-5	21 mm	21 mm / Ø4 mm / SS	0.21 µm	0.18 µm	2.1 µm	1.0 µm	0.2 mm	2831
SM25-5	105 mm	100 mm / Ø5 mm / CF	0.48 µm	0.28 µm	4.2 µm	1.6 µm	0.2 mm	2643

SP25M user's guide

www.renishaw.com

Bi-directional ring gauge scan test - cranked styli

Scanning module	Crank configuration	Actual M3 stylus used: Length / tip Ø / stem material (mounted to crank centre)	RMS data raw	RMS data filtered	SPAN data raw	SPAN data filtered	Stylus tip deflection	Raw data points
SM25-1	25 mm 'down' 28 mm 'out'	21 mm / Ø4 mm / SS	0.26 µm	0.19 µm	1.9 µm	0.9 µm	0.2 mm	2858
SM25-1	25 mm 'down' 57.5 mm 'out'	50 mm / Ø5 mm / CER	0.62 µm	0.56 µm	6 µm	3.2 µm	0.2 mm	2794
SM25-1	55 mm 'down' 28 mm 'out'	21 mm / Ø4 mm / SS	0.28 µm	0.16 µm	3 µm	1 µm	0.2 mm	2868
SM25-1	55 mm 'down' 57.5 mm 'out'	50 mm / Ø5 mm / CER	0.36 µm	0.24 µm	4.9 µm	1.6 µm	0.2 mm	2796
Scanning module	Crank configuration	Actual M3 stylus used: Length / tip Ø / stem material (mounted to crank centre)	RMS data raw	RMS data filtered	SPAN data raw	SPAN data filtered	Stylus tip deflection	Raw data points
SM25-2	55 mm 'down' 28 mm 'out'	21 mm / Ø4 mm / SS	0.6 µm	0.56 µm	3.1 µm	2.3 µm	0.2 mm	2858
SM25-2	55 mm 'down' 57.5 mm 'out'	50 mm / Ø5 mm / CER	0.33 µm	0.26 µm	2.8 µm	1.5 µm	0.2 mm	2857
SM25-2	55 mm 'down' 83 mm 'out'	75 mm / Ø6 mm / GF	0.55 µm	0.47 µm	4.1 µm	2.4 µm	0.35 mm	2733
SM25-2	85 mm 'down' 28 mm 'out'	21 mm / Ø4 mm / SS	0.35 µm	0.24 µm	4.5 µm	1.9 µm	0.2 mm	2858
SM25-2	85 mm 'down' 57.5 mm 'out'	50 mm / Ø5 mm / CER	0.45 µm	0.36 µm	3 µm	1.7 µm	0.2 mm	2795

SP25M user's guide

www.renishaw.com

SM25-2	85 mm 'down' 83 mm 'out'	75 mm / Ø6 mm / GF	0.75 µm	0.6 µm	6.1 µm	3.6 µm	0.2 mm	2734
SM25-3	105 mm 'down' 28 mm 'out'	21 mm / Ø4 mm / SS	0.4 µm	0.35 µm	2.3 µm	1.7 µm	0.2 mm	2858
SM25-3	105 mm 'down' 57.5 mm 'out'	50 mm / Ø5 mm / CER	0.44 µm	0.38 µm	2.7 µm	1.8 µm	0.2 mm	2858
SM25-3	105 mm 'down' 83 mm 'out'	75 mm / Ø6 mm / GF	0.42 µm	0.36 µm	3 µm	1.8 µm	0.2 mm	2733
SM25-3	125 mm 'down' 28 mm 'out'	21 mm / Ø4 mm / SS	0.47 µm	0.42 µm	2.7 µm	1.8 µm	0.2 mm	2856
SM25-3	125 mm 'down' 57.5 mm 'out'	50 mm / Ø5 mm / CER	0.47 µm	0.35 µm	2.7 µm	1.8 µm	0.2 mm	2856
SM25-3	125 mm 'down' 83 mm 'out'	75 mm / Ø6 mm / GF	0.55 µm	0.46 µm	3.5 µm	2.1 µm	0.35 mm	2732
SM25-3	155 mm 'down' 28 mm 'out'	21 mm / Ø4 mm / SS	0.38 µm	0.31 µm	2.6 µm	1.5 µm	0.2 mm	2858
SM25-3	155 mm 'down' 57.5 mm 'out'	50 mm / Ø5 mm / CER	0.37 µm	0.27 µm	2.9 µm	1.3 µm	0.2 mm	2858
SM25-3	155 mm 'down' 83 mm 'out'	75 mm / Ø6 mm / GF	1.01 µm	0.69 µm	11.8 µm	3.5 µm	0.2 mm	2734

SP25M user's guide

www.renishaw.com

Scanning module	Crank configuration	Actual M3 stylus used: Length / tip Ø / stem material (mounted to crank centre)	RMS data raw	RMS data filtered	SPAN data raw	SPAN data filtered	Stylus tip deflection	Raw data points
SM25-4	205 mm 'down' 28 mm 'out'	21 mm / Ø4 mm / SS	0.45 µm	0.38 µm	2.6 µm	2 µm	0.2 mm	1439
SM25-4	205 mm 'down' 57.5 mm 'out'	50 mm / Ø5 mm / CER	0.38 µm	0.26 µm	2.5 µm	1.5 µm	0.2 mm	1440
SM25-4	205 mm 'down' 83 mm 'out'	75 mm / Ø6 mm / GF	0.51 µm	0.34 µm	4.2 µm	2.2 µm	0.2 mm	1376
SM25-4	225 mm 'down' 28 mm 'out'	21 mm / Ø4 mm / SS	0.41 µm	0.32 µm	2.7 µm	1.8 µm	0.2 mm	1438
SM25-4	225 mm 'down' 57.5 mm 'out'	50 mm / Ø5 mm / CER	0.42 µm	0.3 µm	2.6 µm	2.7 µm	0.2 mm	1438
SM25-4	225 mm 'down' 83 mm 'out'	75 mm / Ø6 mm / GF	0.65 µm	0.48 µm	5.1 µm	2.4 µm	0.35 mm	2731
SM25-4	255 mm 'down' 28 mm 'out'	21 mm / Ø4 mm / SS	0.67 µm	0.59 µm	3.6 µm	2.5 µm	0.2 mm	2858
SM25-4	255 mm 'down' 57.5 mm 'out'	50 mm / Ø5 mm / CER	0.69 µm	0.55 µm	5.9 µm	2.8 µm	0.2 mm	2794
SM25-4	255 mm 'down' 83 mm 'out'	75 mm / Ø6 mm / GF	0.99 µm	0.75 µm	8.5 µm	3.9 µm	0.2 mm	2730

SP25M user's guide

www.renishaw.com

Test setup criteria

Test site	Renishaw UK
Styli used	Renishaw's M3 stylus range
CMM specification	$U^3 = 0.48 \mu\text{m} + L / 1000$
CMM controller	Renishaw's UCC2
Probe calibration	Renishaw's third order polynomial calibration method
Data filter used	Harmonic simple cut off order = 60 UPR (undulations per revolution)
Artefacts used	Ø25 mm (nom) calibration sphere (for the ISO 10360 Part 2 / Part 4 tests) Ø50 mm (nom) ring gauge (for the ring gauge scan tests)
Scanning speed	5 mm/s (for the ISO 10360 Part 4 and ring gauge scan tests)
Touch speed	5 mm/s (for the ISO 10360 Part 2 tests)
Back off speed	1 mm/s (for the ISO 10360 Part 2 tests)
Bi-directional scans	<p>The effect of probe misalignment and contact friction will result in radius changes with scanning direction if a suitable calibration procedure is not used.</p> <p>Mechanical hysteresis within a probe mechanism is best demonstrated by a bi-directional scan.</p> <p>Therefore, Renishaw have decided to take the high integrity approach of quoting ring gauge metrology using bi-directional scan data to demonstrate the performance of the Renishaw probe and calibration method.</p>

SP25M user's guide

www.renishaw.com

SH25 stylus holder range metrology performance

SH25-2A, SH25-3A and SH25-4A have distinct metrology advantages over SH25-2, SH25-3 and SH25-4 for any stylus arrangements where the stylus holder is subjected to torsional load when using components like cranked styli or knuckle joints.

The standard range of SH25 stylus holders still have an advantage over the -A range of stylus holders when straight styli arrangements are required.

The following tables compare typical metrology performance with the standard and -A range of SH25 stylus holders for both straight and cranked stylus configurations.

SH25-2 against SH25-2A - bi-directional ring gauge scan test

Straight stylus performance - effective stylus reach 51 mm:

Stylus holder	SPAN data raw	SPAN data filtered	Stylus tip deflection
SH25-2	1.6 µm	1.2 µm	0.2 mm
SH25-2A	1.5 µm	1.1 µm	0.2 mm

Cranked stylus performance - crank down distance 55 mm, crank out distance 83 mm:

Stylus holder	SPAN data raw	SPAN data filtered	Stylus tip deflection
SH25-2	14.9 µm	5.9 µm	0.35 mm
SH25-2A	4.1 µm	2.4 µm	0.35 mm

SH25-3 against SH25-3A - bi-directional ring gauge scan test

Straight stylus performance - effective stylus reach 121 mm:

Stylus holder	SPAN data raw	SPAN data filtered	Stylus tip deflection
SH25-3	2.2 µm	1.3 µm	0.2 mm
SH25-3A	2.5 µm	1.7 µm	0.2 mm

Cranked stylus performance - crank down distance 125 mm, crank out distance 83 mm:

Stylus holder	SPAN data raw	SPAN data filtered	Stylus tip deflection
SH25-3	11.8 µm	8.2 µm	0.35 mm
SH25-3A	3.5 µm	2.1 µm	0.35 mm

SP25M user's guide

www.renishaw.com

SH25-4 against SH25-4A - bi-directional ring gauge scan test

Straight stylus performance - effective stylus reach 221 mm:

Stylus holder	SPAN data raw	SPAN data filtered	Stylus tip deflection
SH25-4	3.0 µm	1.7 µm	0.2 mm
SH25-4A	3.5 µm	2.4 µm	0.2 mm

Cranked stylus performance - crank down distance 225 mm, crank out distance 83 mm:

Stylus holder	SPAN data raw	SPAN data filtered	Stylus tip deflection
SH25-4	15.7 µm	5.0 µm	0.35 mm
SH25-4A	5.1 µm	2.4 µm	0.35 mm

Test setup criteria

Test site	Renishaw UK
Styli used	Renishaw's M3 stylus range
CMM specification	$U^3 = 0.48 \mu\text{m} + L / 1000$
CMM controller	Renishaw's UCC2
Probe calibration	Renishaw's third order polynomial calibration method
Data filter used	Harmonic simple cut off order = 60 UPR (undulations per revolution)
Artefacts used	Ø25 mm (nom) calibration sphere (for the ISO 10360 Part 2 / Part 4 tests) Ø50 mm (nom) ring gauge (for the ring gauge scan tests)
Scanning speed	5 mm/s (for the ISO 10360 Part 4 and ring gauge scan tests)
Touch speed	5 mm/s (for the ISO 10360 Part 2 tests)
Back off speed	1 mm/s (for the ISO 10360 Part 2 tests)
Bi-directional scans	The effect of probe misalignment and contact friction will result in radius changes with scanning direction if a suitable calibration procedure is not used. Mechanical hysteresis within a probe mechanism is best demonstrated by a bi-directional scan. Therefore, Renishaw have decided to take the high integrity approach of quoting ring gauge metrology using bi-directional scan data to demonstrate the performance of the Renishaw probe and calibration method.

SP25M user's guide

www.renishaw.com

SP25M disc styli carrying capability

SP25M is compatible with disc styli when using the SM25-1, SM25-2, SM25-3 or SM25-4 scanning modules and their respective standard stylus holders.

For SM25-1 and SM25-2, it is mandatory that a 20 mm long extension must be used between the respective stylus holder and disc stylus unless the disc has an effective working length of 20 mm or more.

SP25M - SH25-#

Module / stylus holder	SM25-1 / SH25-1	SM25-2 / SH25-2	SM25-3 / SH25-3	SM25-4 / SH25-4
Effective stylus reach (by using these extensions * between the stylus holder and the disc)	20 mm (20 mm)	50 mm (20 mm)	100 mm to 150 mm (0 mm to 50 mm)	200 mm to 250 mm (0 mm to 50 mm)
Maximum permissible disc stylus length vs mass	20 mm (9 g ^{***})	20 mm (6 g ^{***})	0 mm (13 g) 20 mm (12 g ^{***}) ^{**} 50 mm (11 g ^{****})	0 mm (11 g) 20 mm (10 g ^{***}) 50 mm (8 g ^{****})
Maximum operating stylus tip deflection for above in any orientation	0.4 mm	0.4 mm	0.4 mm	0.4 mm

* For example, use part number M-5000-3592 (20 mm long × M3 stainless steel extension)

** Representative test results for these configurations is shown in the tables in [Disc stylus performance](#)

*** This excludes the mass of the 20 mm extension

**** This excludes the mass of the 50 mm extension

SP25M user's guide

www.renishaw.com

SP25M - SH25-#A

Module / stylus holder	SM25-2 / SH25-2A	SM25-3 / SH25-3A	SM25-4 / SH25-4A
Effective stylus reach (by using these extensions * between the stylus holder and the disc)	50 mm (20 mm)	100 mm to 150 mm (0 mm to 50 mm)	100 mm to 150 mm (0 mm to 50 mm)
Maximum permissible disc stylus length vs mass	20 mm (6 g ^{***})	0 mm (13 g) 20 mm (12 g ^{***})** 50 mm (11 g ^{****})	0 mm (11 g) 20 mm (10 g ^{***}) 50 mm (8 g ^{****})
Maximum operating stylus tip deflection for above in any orientation	0.4 mm	0.4 mm	0.4 mm

* For example, use part number M-5000-3592 (20 mm long × M3 stainless steel extension)

** Representative test results for these configurations is shown in the tables in [Disc stylus performance](#)

*** This excludes the mass of the 20 mm extension

**** This excludes the mass of the 50 mm extension

SP25M user's guide

www.renishaw.com

Disc stylus performance

SS - stainless steel, CER - ceramic

Bi-directional ring gauge scan test

Scanning module (PH10 axis position)	Effective stylus reach	Actual disc stylus used: Diameter / material	RMS data raw	RMS data filtered	SPAN data raw	SPAN data filtered	Stylus tip deflection	Data pts
SM25-3 (A0)	100 mm	Ø30 mm / CER	0.52 µm	0.5 µm	2.9 µm	2.4 µm	0.2 mm	1244
SM25-3 (A0)	120 mm*	Ø35 mm / SS	0.5 µm	0.3 µm	3.7 µm	2.3 µm	0.2 mm	885
SM25-3 (A0)	120 mm*	Ø35 mm / SS	0.4 µm	0.3 µm	2.6 µm	1.8 µm	0.2 mm	896
SM25-3 (A0)	150 mm**	Ø30 mm / CER	0.53 µm	0.48 µm	3.6 µm	2.5 µm	0.2 mm	1244
SM25-4 (A0)	200 mm	Ø30 mm / CER	0.77 µm	0.72 µm	4.5 µm	3.5 µm	0.2 mm	1244
SM25-4 (A0)	250 mm**	Ø30 mm / CER	0.77 µm	0.68 µm	4.2 µm	3.1 µm	0.2 mm	1243

* including the 20 mm extensions

** including the 50 mm extension

Renishaw has developed a lightweight 30 mm diameter disc stylus (A-5003-7098) that will enable two-dimensional scanning with SM25-1 / 2 scanning modules. Alternatively a 12 mm diameter disc stylus (A-5000-3615) is available that can be used with SM25-1 / 2.

SP25M user's guide

www.renishaw.com

Test setup criteria

Test site	Renishaw UK
Styli used	Renishaw's M3 stylus range
CMM specification	$U^3 = 0.48 \mu\text{m} + L / 1000$
CMM controller	Renishaw's UCC2
Probe calibration	Renishaw's third order polynomial calibration method
Data filter used	Harmonic simple cut off order = 60 UPR (undulations per revolution)
Artefacts used	<p>Ø25 mm (nom) calibration sphere (for the ISO 10360 Part 2 / Part 4 tests)</p> <p>Ø50 mm (nom) ring gauge (for the ring gauge scan tests)</p>
Scanning speed	5 mm/s (for the ISO 10360 Part 4 and ring gauge scan tests)
Touch speed	5 mm/s (for the ISO 10360 Part 2 tests)
Back off speed	1 mm/s (for the ISO 10360 Part 2 tests)
Bi-directional scans	<p>The effect of probe misalignment and contact friction will result in radius changes with scanning direction if a suitable calibration procedure is not used.</p> <p>Mechanical hysteresis within a probe mechanism is best demonstrated by a bi-directional scan.</p> <p>Therefore, Renishaw have decided to take the high integrity approach of quoting ring gauge metrology using bi-directional scan data to demonstrate the performance of the Renishaw probe and calibration method.</p>

SP25M user's guide

www.renishaw.com

Extensions

The SP25M can be used with the PEM25 (25 mm), PEM1 (50 mm) and PEM2 (100 mm) autojoint to autojoint extension bars to extend the effective probe reach.



CAUTION: SP25M cannot be used with the PEM3 (200 mm).

SP25M user's guide

www.renishaw.com

SP25M maintenance

The SP25M probe, SM25 scanning modules and SH25 stylus holders have no user serviceable parts. In the event of a problem, contact your local Renishaw supplier for assistance.

Following the simple maintenance procedures below will help to prolong the operation life and continued high performance of the system. The user should determine the frequency of inspection and maintenance according to the conditions of use.



CAUTION: Always adhere to the general safety recommendations in this document. Failure to do so could adversely affect the performance of the probe system and / or lead to personal injury.

SP25M probe system components

The external surfaces of all system components should be cleaned with a soft, lint free cloth. All parts must always be kept dry.

The kinematic coupling mechanisms incorporated throughout the system have a precision ball and V-groove seating, electrical contacts and permanent magnets. It is recommended that all these features are cleaned before first use and then at intervals after 500 tool changes.

A cleaning kit for the above components is available from your local Renishaw supplier (part number: A-1085-0016). With clean hands, tear off a small amount of yellow tack, shape in to a ball and press on to each feature in turn to remove debris.

The optical windows that feature as part of the probe and module assemblies should be carefully cleaned using the yellow tack supplied in the cleaning kit (part number: A-1085-0016). The optical windows are made of glass and should be cleaned with care to avoid damage or personal injury.

All probe system components that are not being used and are not stored in the rack should be kept in their original transportation packaging boxes.

FCR25 and FCR25 TC flexible change racks

The ports, lids and outer surfaces of the FCR25 racks should be periodically cleaned using a soft, lint free cloth to prevent the contamination of the probe system components. A port replacement kit is available if required (FCR25: A-5036-0049, FCR25 TC: A-2237-0050).

Styli

Stylus balls, threads and mating faces should be cleaned using a proprietary cleaning cloth or solvent. Stylus balls should be regularly inspected for damage or pick-up of component material.

Appendix 1 - SP25M international safety recommendations

SP25M user's guide

www.renishaw.com

BG - Общи препоръки по безопасност



ВНИМАНИЕ: Преди разпаковане и монтиране на пробниковата система SP25M, потребителят трябва внимателно да прочете инструкциите по безопасност по-долу и да гарантира, че те ще се спазват през цялото време от всички оператори, използващи пробниковата система. Употребата на органи за управление или настройка, или изпълнението на процедури, различни от тук посочените, може да доведе до експозиция на опасно инфрачервено излъчване. Операторите трябва да са обучени в употребата и прилагането на пробниковата системата SP25M и придружаващите я продукти, към които се монтира машината преди да могат да работят с тази машина.



ЗАБЕЛЕЖКА: По-долу са направени препратки към функции, които са обозначени с [†] [‡] [◆] в следващите илюстрации. Моля, уверете се че ясно разбирате всички съвети за безопасност. Препоръчва се запозване с компонентите на системата SP25M по показания в следващите раздели начин:

- Преглед на компонентите на системата
- Схема на компонентите на пробниковата система
- Схема на гъвкавата за смяна стойка FCR25
- Схема на гъвкавата за смяна стойка FCR25 TC

Пробниковата система SP25M има механична защита от излизане извън работния ход, осигурена по ос +Z в пробника от неподвижен краен изключвател с буфер. Тогава контролната система на машината ще трябва да може да спре нейното движение, в тази ос на пробника, преди да бъде достигнат ограничителя. Ако това не е така, потребителят трябва да носи предпазни средства за очите по време на работа в случай на счупване на острието.

Трябва да се внимава, за да се гарантира, че оптичните прозорци (обозначени с [◆]), разположени както на тялото, така и на модула, не се повреждат, тъй като те са изработени от стъкло и могат да предизвикат травма.



ВНИМАНИЕ: В някои компоненти на системата SP25M и свързаните с нея продукти са използвани постоянни магнити. Важно е те да се пазят от елементи, които биха могли да бъдат засегнати от магнитни полета, напр. – системи за запаметяване на данни, водачи, часовници и др.

SP25M user's guide

www.renishaw.com

Безопасност на светодиодите

Корпусът на SP25M съдържа вградени мощни LED източници (обозначени с [†]), които излъчват невидима инфрачервена радиация. Тези източници са открити, когато не е захванат модул SM25-# или TM25-20.

Отстраняването на модула прекъсва два набора от взаимно свързани превключвателни контакта (обозначени с [‡]), за да бъде автоматично изключено захранването към LED и да се гарантира безопасността на потребителя.

Контактите на превключвателя трябва да се проверяват през редовни интервали, за да се гарантира, че са чисти и без замърсители на въздуха като прах, отломки или стружки. При малко вероятни обстоятелства такова замърсяване би могло да причини късо съединение на пиновете и да увеличи риска от подаване на захранване към светодиодите без прикачен модул. Да не се свързват проводими предмети към или между контактите. Да се спазват инструкциите за почистване в раздел за поддръжка.

Преди проверка да се сваля винаги корпусът на SP25M от главата на пробника.

В случай на сериозна повреда или разкъсване на част от корпуса на SP25M или външния кожух на модула за сканиране, изключете ВЕДНАГА захранващия източник, свалете и не опитвайте да използвате повторно детайлите и се свържете с вашия доставчик за съвет.

Илюстрации за безопасност

Тези диаграми показват функции, които са означени с [†] [‡] [◆], и които са споменати в тези препоръки за безопасност.

Корпус на пробника SP25M

Поглед от края, показващ кинематичната връзка с модула



Кинематична връзка на SP25M с модула

Модули за сканиране SM25

Поглед от края, показващ кинематичната връзка с корпуса



Кинематична връзка на SP25M с корпуса

SP25M user's guide

www.renishaw.com

CZ - Obecná bezpečnostní doporučení



UPOZORNĚNÍ: Před vybalením a instalací skenovacího systému SP25M by si měl uživatel pozorně přečíst níže uvedené bezpečnostní pokyny a zajistit, aby je všechny osoby používající skenovací systém neustále dodržovaly. Při použití jiných ovládacích prvků či jiných nastavení nebo při provádění jiných postupů než těch, které jsou zde uvedeny, můžete být vystaveni nebezpečnému infračervenému záření.

Než bude moci obsluha začít pracovat se strojem, ke kterému je připojen skenovací systém SP25M, je nutné, aby byla vyškolená v oblasti používání tohoto systému a doplňujících produktů v souvislosti s daným strojem.

POZNÁMKA: Odkazy v následujícím textu se vztahují k prvkům označeným značkami [†] [‡] [◆] na obrázcích dole. Ujistěte se, že všem bezpečnostním pokynům zcela rozumíte. Doporučujeme seznámit se se součástmi systému SP25M, které jsou znázorněny v těchto částech:



- Přehled součástí systému
- Schéma součástí snímacího systému
- Schéma flexibilního výměníku FCR25
- Schéma flexibilního výměníku FCR25 TC

Snímací systém SP25M obsahuje mechanickou ochranu před nadměrným zdvihem, která je v ose +Z tvořena pevnou zářezkou. Řídicí systém stroje proto musí být schopen před dosažením zářezky zastavit svůj pohyb ve směru osy sondy. V opačném případě musí uživatel během provozu používat ochranu zraku pro případ zlomení doteku.

Pozornost by měla být věnována také tomu, zda nejsou poškozena optická okénka (označena značkou [◆]) umístěná na hlavní části i na modulu. Tato okénka jsou vyrobena ze skla a mohla by být příčinou zranění.



UPOZORNĚNÍ: V některých součástech systému SP25M a přidružených produktů jsou použity permanentní magnety. Je nutné je uchovávat mimo dosah předmětů, na které by mohlo nepříznivě působit magnetické pole, jako jsou například systémy pro ukládání dat, kardiostimulátory, hodinky atd.

SP25M user's guide

www.renishaw.com

LED kontrolka

V tělese SP25M jsou integrovány zdroje LED s vysokou intenzitou (označené značkou [†]), které vysílají neviditelné infračervené záření. Tyto zdroje jsou odkryty v případě, že není připojen modul SM25-# nebo modul TM25-20.

Při odebrání modulu dojde k přerušení dvou sad ochranných kontaktů vypínače (označeny značkou [‡]) a tím k automatickému odpojení napájení zařízení LED a zajištění bezpečnosti uživatelů.

Pravidelnou prohlídkou a kontrolou ochranných kontaktů by mělo být zjištěno, zda jsou čisté a zda neobsahují vzduchem přenášené nečistoty, jako je například prach nebo třísky odletující při obrábění. Za určitých, málo pravděpodobných okolností by takové znečištění mohlo mezi kolíky způsobit zkrat a tím by došlo ke zvýšení rizika, že bude zařízení LED napájeno, i když nebude připojen žádný modul. Ke kontaktům nikdy nepřipojujte vodivé předměty. Postupujte podle návodu na čištění v kapitole o údržbě.

Před kontrolou vždy demontujte tělo SP25M ze snímací hlavy.

V případě poškození nebo natržení jakékoliv části vnějšího obalu tělesa SP25M nebo skenovacího modulu, OKAMŽITĚ odpojte napájecí zdroj, poškozený díl demontujte a zajistěte, že nebude dále používán. Dále kontaktujte vašeho dodavatele.

Obrázky týkající se bezpečnosti

Tato schématická znázornění ukazují prvky, označené [†] [‡] [◆], na které jsou uvedeny odkazy v těchto bezpečnostních doporučeních.

Těleso sondy SP25M

Pohled na koncovou část znázorňující kinematický spoj s modulem



Kinematický spoj s modulem systému SP25M

Skenovací moduly SP25M

Pohled na koncovou část znázorňující kinematický spoj s tělesem

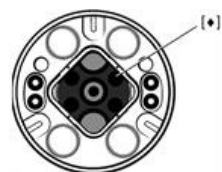

Kinematický spoj s tělesem systému SP25M

SP25M user's guide

www.renishaw.com

DA - Generelle sikkerhedsanbefalinger



FORSIGTIG! Før udpakning og installation af SP25M-probesystemet skal brugeren omhyggeligt læse nedenstående sikkerhedsinstruktioner og sørge for, at de altid bliver fulgt af alle, der betjener probesystemet. Brug af kontrolenheder, justeringsenheder eller ydelsesprocedurer ud over dem, som er angivet heri, kan bevirke, at man udsættes for farlig infrarød stråling.

Operatørerne skal være uddannet i brugen og anvendelsen af SP25M-probesystemet og de medfølgende produkter i forbindelse med den maskine, det er monteret på, før de får tilladelse til at betjene maskinen.

BEMÆRK: Nedenfor henvises der til funktioner, der er angivet med [†] [‡] [◆] på illustrationerne nedenfor. Sørg for, at du forstår alle sikkerhedsinstruktionerne fuldstændigt. Det anbefales at gøre sig bekendt med SP25M-systemkomponenterne som vist i afsnittene:



- Oversigt over systemkomponenter
- Skematisk diagram over probesystemets komponenter
- Skematisk diagram over FCR25 fleksibelt rack
- Skematisk diagram over FCR25 TC fleksibelt rack

SP25M-probesystemet er forsynet med mekanisk beskyttelse mod at bevæge sig for langt i form af et fast endestop i probens +Z-akseretning. Maskinens kontrolsystem skal derfor være i stand til at stoppe maskinens bevægelse, i denne akseretning for proben, før endestoppet nås. Hvis dette ikke er tilfældet, skal brugeren være iført beskyttelsesbriller under betjeningen i tilfælde af, at stylus knækker.

Pas på, at de optiske vinduer (angivet med [◆]), der findes både i enheden og modulet, ikke bliver beskadigede, da de er fremstillet af glas og kan forårsage kvæstelser.



FORSIGTIG! Der anvendes permanente magneter i visse komponenter i SP25M-systemet og de tilhørende produkter. Det er vigtigt at holde dem på afstand af komponenter, der kan påvirkes af magnetiske felter, f.eks. datalagringsystemer, pacemakere, ure osv.

SP25M user's guide

www.renishaw.com

LED sikkerhed

SP25M-enheden indeholder kraftige integrerede LED-kilder (angivet med [†]), der udsender usynlig infrarød stråling. Disse kilder er fri, når SM25-# eller TM25-20-modulet ikke er monteret.

Fjernelse af modulet afbryder to sæt låsekontakter (angivet med [‡]), så LED-strømforsyningen automatisk afbrydes, og brugeren er sikret.

Låsekontakterne skal med passende mellemrum undersøges og kontrolleres, så de er rene og fri for luftbåren kontaminering - f.eks. støv, snavs eller metalspån. Under usædvanlige omstændigheder kan en sådan kontaminering forårsage kortslutning af stifterne og derved øge risikoen for, at LED'erne forsynes med strøm, uden at der er et modul monteret. Forbind aldrig ledende genstande til eller mellem kontakterne. Følg rengøringsanvisningerne i vedligeholdelsesafsnittet.

Før undersøgelse skal SP25M-enheden altid fjernes fra probehovedet.

I tilfælde af alvorlig skade på, eller brud på, dele af SP25M-enheden eller scannemodules ydre metaldele, skal man ØJEBLIKKELT afbryde strømforsyningen, fjerne og ikke forsøge at genbruge delene, og kontakte leverandøren for hjælp.

Sikkerhedsillustrationer

Disse diagrammer viser funktioner, der er angivet med [†] [‡] [◆], som der henvises til i disse sikkerhedsanbefalinger.

SP25M probeenhed

Afbildning set fra siden, der viser kinematisk forbindelse til modulet



SP25M kinematisk forbindelse til modulet

SM25-scanningsmoduler

Afbildning set fra siden, der viser kinematisk forbindelse til enheden



SP25M kinematisk forbindelse til enheden

DE - Allgemeine Sicherheitsempfehlungen



ACHTUNG: Vor dem Auspacken und Installieren des SP25M-Messtastersystems lesen sie bitte sorgfältig die folgenden Sicherheitshinweise und sorgen sie dafür, dass diese auch von allen Anwendern dieses Systems beachtet werden. Eine anderweitige Benutzung der Steuerungen oder Einstellungen, oder das Anwenden anderer Verfahren als die hier beschriebenen kann zum Austritt gefährlicher Infrarotstrahlung führen.

Vor Bedienung der Maschine muss das Bedienungspersonal über Gebrauch und Anwendung des SP25M-Messtastersystems und der zugehörigen Produkte in Verbindung mit der damit ausgerüsteten Maschine geschult werden.



HINWEIS: Nachfolgend wird auf bestimmte, durch [†] [‡] [◆] gekennzeichnete Eigenschaften in den Abbildungen unten verwiesen. Achten Sie darauf, dass Sie sämtliche Sicherheitshinweise richtig verstehen. Machen Sie sich mit dem System vertraut, wie in den folgenden Abschnitten beschrieben:

- Systemkomponenten im Überblick
- Schematische Darstellung der Systemkomponenten
- Schematische Darstellung des flexiblen FCR25 Wechselsystems
- Schematische Darstellung des flexiblen FCR25 TC Wechselsystems

Das SP25M Messtastersystem besitzt in der positiven Z-Achse einen mechanischen Überlaufschutz in Form eines Endanschlags. Die Maschinensteuerung muss deshalb in der Lage sein, die Maschinenbewegung in der Achse des Messtasters zum Halten zu bringen, bevor der Endanschlag erreicht wird. Ist dies nicht der Fall, muss der Anwender beim Betrieb einen Augenschutz tragen, da der Taster brechen könnte.

Achten Sie darauf, dass die optischen Fenster (gekennzeichnet durch [◆]) an der Tasteraufnahme und am Modul nicht beschädigt werden. Sie sind aus Glas und können zu Verletzungen führen.



ACHTUNG: In einigen Bauteilen des SP25M-Systems und einigen dazugehörigen Produkten sind Permanentmagneten eingebaut. Wichtig! Halten Sie diese von Geräten fern, die durch Magnetfelder beeinträchtigt werden können, wie z. B. Datenspeicher, Herzschrittmacher, Uhren usw.

SP25M user's guide

www.renishaw.com

LED Sicherheit

Im Sensorgehäuse des SP25M-Systems befinden sich eingeschlossene Hochleistungs-LEDs (gekennzeichnet durch [†]), welche unsichtbares Infrarotlicht ausstrahlen. Die Strahlen können austreten, wenn Modul SM25-# oder Modul TM25-20 nicht montiert sind.

Beim Entfernen des Moduls werden zwei Verriegelungskontakte (gekennzeichnet durch [‡]) unterbrochen. Die LED-Stromversorgung wird hierdurch automatisch abgeschaltet, der Anwender wird geschützt.

In geeigneten Zeitabständen sollten die Verriegelungskontakte überprüft werden. Stellen Sie sicher, dass diese sauber und frei von Staub, Spänen und sonstigen Verunreinigungen sind. Wenn auch unwahrscheinlich, so kann eine solche Verschmutzung zu einem Kurzschluss an den Stiften führen. Dies erhöht das Risiko, dass Strom zu den LEDs fließt, obwohl kein Modul befestigt ist. Bringen Sie niemals leitende Gegenstände an oder zwischen die Kontakte. Beachten Sie die Anweisungen für die Reinigung im Abschnitt „Instandhaltung“.

Vor einer Inspektion immer den SP25M vom Tastkopf entfernen.

Im Falle einer größeren Beschädigung oder Bruch eines Gehäuseteils des SP25M oder des Gehäuses des Scan-Modules muss SOFORT die Stromzufuhr unterbrochen und der beschädigte Messtaster entfernt werden. Bitten Sie Ihren Lieferanten um Unterstützung; versuchen Sie nicht Teile wiederzuverwenden.

Sicherheitsmerkmale

Auf die durch [†] [‡] [◆] gekennzeichneten Merkmale wird in diesen Sicherheitshinweisen verwiesen.

SP25M Tasteraufnahme

Kinematische Verbindungsfläche zum Modul (Draufsicht)

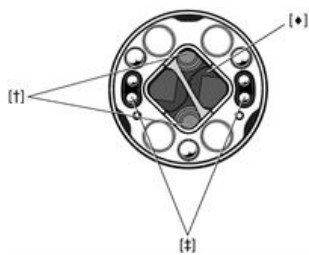

SP25M kinematische Verbindungsfläche zum Modul

SM25 Scanmodule

Kinematische Verbindungsfläche zur Tasteraufnahme (Draufsicht)

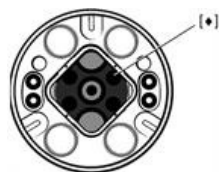

SP25M kinematische Verbindungsfläche zur Tasteraufnahme

SP25M user's guide

www.renishaw.com

ΕΛ - Γενικές συστάσεις ασφάλειας



ΠΡΟΣΟΧΗ: Πριν από την αποσυσκευασία και εγκατάσταση του συστήματος αισθητήρα SP25M, ο χρήστης πρέπει να διαβάσει προσεκτικά τις οδηγίες ασφάλειας που ακολουθούν και να διασφαλίσει ότι θα εφαρμόζονται πάντοτε από όλους τους χειριστές του συστήματος. Η χρήση χειριστηρίων ή ρυθμίσεων, καθώς και η εκτέλεση διαδικασιών διαφορετικών από αυτές που καθορίζονται στο παρόν μπορεί να προκαλέσει έκθεση σε επικίνδυνη υπέρυθη ακτινοβολία.

Οι χειριστές πρέπει να είναι εκπαιδευμένοι στη χρήση και εφαρμογή του συστήματος αισθητήρα SP25M και των συνοδευτικών προϊόντων, σε σχέση με το μηχάνημα στο οποίο τοποθετείται, για να τους επιτραπεί να χρησιμοποιήσουν το συγκεκριμένο μηχάνημα.

ΣΗΜΕΙΩΣΗ: Γίνονται αναφορές κατωτέρω σε χαρακτηριστικά που δηλώνονται ως [†] [‡] [◆] στις απεικονιζόμενες παρακάτω εικόνες. Παρακαλούμε να βεβαιωθείτε ότι κατανοείτε σαφώς όλες τις οδηγίες ασφάλειας. Συστήνεται η εξοικείωση με τα στοιχεία του συστήματος SP25M, όπως φαίνεται στα ακόλουθα αποσπάσματα:

- Επισκόπηση μερών του συστήματος
- Σχηματικό διάγραμμα των μερών του συστήματος αισθητήρα
- Σχηματικό διάγραμμα του εύκαμπτου πλαισίου στήριξης αλλαγής FCR25
- Σχηματικό διάγραμμα του εύκαμπτου πλαισίου στήριξης αλλαγής FCR25 TC



Το σύστημα αισθητήρα SP25M διαθέτει μηχανική προστασία υπέρβασης διαδρομής η οποία παρέχεται στον άξονα +Z του αισθητήρα, από έναν σταθερό αποσβεστήρα κρούσεων. Το σύστημα ελέγχου του μηχανήματος πρέπει επομένως να είναι σε θέση να διακόπτει την κίνηση της μηχανής, στο συγκεκριμένο άξονα του αισθητήρα, πριν από την προσέγγιση στον αποσβεστήρα κρούσεων. Σε διαφορετική περίπτωση, ο χρήστης πρέπει να φοράει συσκευή προστασίας των ματιών όταν χειρίζεται το μηχάνημα για την περίπτωση θραύσης του επαφά.

Πρέπει να φροντίσετε ώστε να εξασφαλιστεί ότι τα οπτικά παράθυρα (αναφέρονται ως [◆]), τα οποία βρίσκονται στο σώμα και στην υπομονάδα, δεν πρόκειται να πάθουν ζημιά επειδή είναι κατασκευασμένα από γυαλί και μπορεί να προκαλέσουν τραυματισμό.



ΠΡΟΣΟΧΗ: Σε ορισμένα εξαρτήματα του συστήματος SP25M και των σχετικών προϊόντων χρησιμοποιούνται μόνιμοι μαγνήτες. Είναι σημαντικό να κρατάτε τους μαγνήτες μακριά από στοιχεία που μπορεί να επηρεαστούν από μαγνητικά πεδία, π.χ. συστήματα αποθήκευσης δεδομένων, βηματοδότες, ρολόγια, κ.λπ.

SP25M user's guide

www.renishaw.com

Ασφάλεια με LED

Το σώμα του SP25M περιέχει ενσωματωμένες πηγές LED υψηλής ισχύος (δηλώνονται με το σύμβολο [†]) οι οποίες εκπέμπουν αόρατη υπέρυθη ακτινοβολία. Οι πηγές αυτές είναι εκτεθειμένες όταν δεν είναι τοποθετημένη μια υπομονάδα SM25-# ή TM25-20.

Η αφαίρεση της υπομονάδας απομακρύνει δύο ομάδες επαφών διακοπών ασφαλείας (δηλώνονται με [#]) ώστε να διακόπτεται αυτόματα η τροφοδότηση ισχύος στις φωτοдиодους LED και να διασφαλίζεται η ασφάλεια του χρήστη.

Σε κατάλληλα χρονικά διαστήματα, οι επαφές των διακοπών ασφαλείας πρέπει να επιθεωρούνται και να ελέγχονται ώστε να εξασφαλίζεται ότι είναι καθαρές και χωρίς αερομεταφερόμενους ρύπους, όπως σκόνη, θραύσματα ή ρινίσματα. Σε σπάνιες περιπτώσεις, αυτού του είδους η ρύπανση μπορεί να προκαλέσει βραχυκύκλωμα στους ακροδέκτες και να αυξήσει με αυτόν τον τρόπο τον κίνδυνο να τροφοδοτούνται οι φωτοдиодοι LED με ισχύ, χωρίς να έχει τοποθετηθεί κάποια υπομονάδα. Μη συνδέετε ποτέ αντικείμενα που είναι καλοί αγωγοί του ηλεκτρικού ρεύματος στις, ή ανάμεσα στις, επαφές. Ακολουθήστε τις οδηγίες καθαρισμού που δίνονται στην ενότητα Συντήρηση.

Πριν από την επιθεώρηση, να αφαιρείτε πάντοτε το σώμα του SP25M από την κεφαλή του αισθητήρα.

Σε περίπτωση σοβαρής ζημιάς ή θραύσης οποιουδήποτε τμήματος του σώματος του SP25M ή του εξωτερικού περιβλήματος της μονάδας σάρωσης, αποσυνδέστε ΑΜΕΣΑ την παροχή ρεύματος, αφαιρέστε και μην προσπαθήσετε να ξαναχρησιμοποιήσετε τα κομμάτια, και επικοινωνήστε με τον προμηθευτή σας για οδηγίες.

SP25M user's guide

www.renishaw.com

Εικόνες ασφαλείας

Αυτά τα διαγράμματα δείχνουν χαρακτηριστικά που δηλώνονται με [†] [‡] [◆] και τα οποία αναφέρονται σε αυτές τις συστάσεις ασφαλείας.

Σώμα αισθητήρα SP25M

Όψη απόληξης που απεικονίζει την κινηματική άρθρωση στην υπομονάδα

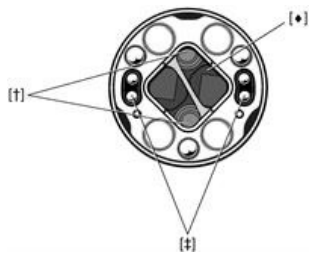

Κινηματική άρθρωση στην υπομονάδα του SP25M

Υπομονάδες σάρωσης SM25

Όψη απόληξης που απεικονίζει την κινηματική άρθρωση στο σώμα

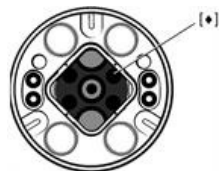

Κινηματική άρθρωση στο σώμα του SP25M

SP25M user's guide

www.renishaw.com

EN - General safety recommendations



CAUTION: Before unpacking and installing the SP25M probe system, the user should carefully read the safety instructions below and ensure that they are followed at all times by all operators using the probe system. Use of controls or adjustments, or performance of procedures other than those specified herein may result in hazardous infra red radiation exposure. Operators must be trained in the use and application of the SP25M probe system and accompanying products, in the context of the machine it is fitted to, before being allowed to operate that machine.

NOTE: References are made below to features indicated [†] [‡] [◆] on the illustrations shown below. Please ensure that you clearly understand all safety instructions. Familiarisation with the SP25M system components, as shown in the following sections is recommended:



- [System components overview](#)
- [Schematic diagram of probe system components](#)
- [Schematic diagram of FCR25 flexible change rack](#)
- [Schematic diagram of FCR25 TC flexible change rack](#)

The SP25M probe system has mechanical overtravel protection provided in the probe +Z axis, by a fixed bumpstop. The machine control system must therefore be able to stop the motion of the machine, in this axis of the probe, before the bumpstop is reached. If this is not the case, the user must wear eye protection during operation in case of stylus breakage.

Care should be taken to ensure that the optical windows (indicated [◆]), located on both body and module, do not become damaged as they are made of glass and could cause injury.



CAUTION: Permanent magnets are used in some components of the SP25M system and associated products. It is important to keep them away from items which may be affected by magnetic fields, e.g. data storage systems, pacemakers and watches etc.

SP25M user's guide

www.renishaw.com

LED safety

The SP25M body contains embedded high power LED sources (indicated [†]) which emit invisible infra-red radiation. These sources are exposed when an SM25-# or TM25-20 module is not attached.

Removing the module breaks two sets of interlock switch contacts (indicated [‡]) to automatically switch off the LED power and assure user safety.

At suitable intervals, the interlock contacts should be inspected and checked to ensure that they are clean and free from airborne contamination such as dust, debris or swarf. In unlikely circumstances, such contamination could cause a short circuit of the pins and thus increase the risk of sending power to the LEDs, without a module being attached. Never connect conducting objects to, or between, the contacts. Follow the cleaning instructions in the [Maintenance](#) section.

Before inspecting, always remove the SP25M body from the probe head.

In the event of serious damage to, or a rupture of, any part of the SP25M body or scanning module outer casing, IMMEDIATELY disconnect power source, remove and do not attempt to re-use the parts, and contact your supplier for advice.

Safety illustrations

These diagrams show features, indicated [†] [‡] [◆] which are referred to within these safety recommendations.

SP25M probe body

End view showing kinematic joint to module

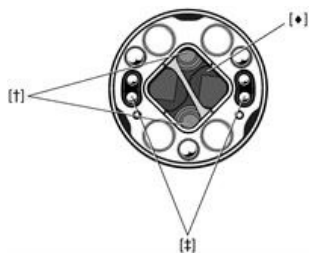

SP25M kinematic joint to module

SM25 scanning modules

End view showing kinematic joint to body

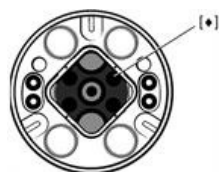

SP25M kinematic joint to body

SP25M user's guide

www.renishaw.com

ES - Recomendaciones generales de seguridad



PRECAUCIÓN: Antes de desempaquetar e instalar el sistema de sonda SP25M, lea atentamente las instrucciones de seguridad siguientes y asegúrese de que son cumplidas en todo momento por los operarios del sistema de sonda. El uso de controles o ajustes, o la realización de procedimientos no especificados en este documento puede provocar exposiciones a radiaciones infrarrojas peligrosas.

Los operadores deben recibir formación sobre el uso y la aplicación del sistema de sonda SP25M y sus accesorios, en el contexto en el que se ajusta la máquina, antes de poder utilizarla.



NOTA: Las referencias a las características se indican con [†] [‡] [◆] en las ilustraciones siguientes. Lea atentamente todas las instrucciones de seguridad hasta que no tenga ninguna duda. Se recomienda familiarizarse con los componentes del sistema SP25M, mostrados en las secciones:

- Descripción general de los componentes del sistema
- Diagrama esquemático de los componentes del sistema de sonda
- Diagrama esquemático del cambiador flexible de FCR25
- Diagrama esquemático del cambiador flexible de FCR25 TC

El sistema de sonda SP25M tiene una protección de sobrerrecorrido mecánica en el eje +Z de la sonda compuesto de un punto de parada fijo. Por lo tanto, el sistema de control de la máquina deberá ser capaz de detener el movimiento de ésta en este eje de la sonda antes de alcanzar el punto de parada fija. Si esto no ocurre, el usuario deberá utilizar gafas de protección para manipular una posible rotura del palpador.

Debe prestarse atención para evitar daños en las ventanas ópticas (marcadas [◆]), situadas en el cuerpo y en el módulo, ya que es de cristal y podría provocar lesiones.



PRECAUCIÓN: Algunos componentes del sistema SP25M y sus accesorios utilizan imanes permanentes. Es muy importante mantenerlos alejados de otros elementos que puedan verse afectados por los campos magnéticos, por ejemplo, sistemas de almacenamiento de datos, marcapasos, relojes, etc.

SP25M user's guide

www.renishaw.com

LED seguridad

El cuerpo de la sonda SP25M lleva integradas fuentes LED de alta tensión [marcadas [†]], que emiten radiación infrarroja invisible. Estas fuentes se exponen cuando no tienen acoplado un módulo SM25-# o TM25-20.

Al retirar los módulos se cortan dos juegos de contactos de interruptores de bloqueo (marcados [†]) para desconectar automáticamente la alimentación del LED y garantizar la seguridad del usuario.

Es preciso inspeccionar y revisar a intervalos pertinentes los contactos de bloqueo para garantizar su limpieza y evitar la contaminación en suspensión, como polvo, partículas extrañas o viruta. En circunstancias poco probables, este tipo de contaminación podría provocar un cortocircuito en las patillas y aumentar el riesgo de enviar alimentación a los LED cuando no tienen un módulo acoplado. No conecte nunca objetos conductores a los contactos o entre ellos. Siga las instrucciones de limpieza de la sección de Mantenimiento.

Antes de examinar el sistema, quite siempre el cuerpo de la sonda SP25M del cabezal.

En caso de serio daño o ruptura de cualquier parte del cuerpo de la sonda SP25M, o del revestimiento exterior del módulo o la sonda copiado, desconecte INMEDIATAMENTE la alimentación, separe y no intente utilizar de nuevo las piezas y contacte con su proveedor para recibir consejo.

Ilustraciones de seguridad

Los diagramas siguientes muestran los elementos, señalados como [†] [‡] [◆] a los que se hace referencia en las instrucciones de seguridad explicadas anteriormente en esta página.

Cuerpo de la sonda SP25M

Vista final que muestra la junta cinemática a módulo



Junta cinemática a módulo SP25M

Módulos de exploración SM25

Vista final que muestra la junta cinemática a la carcasa

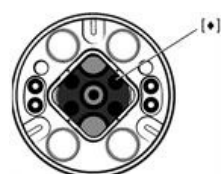

Junta cinemática a la carcasa SP25M

SP25M user's guide

www.renishaw.com

ET - Üldised ohutusjuhised



ETTEVAATUST! Enne SP25M-sondisüsteemi lahtipakkimist ja paigaldamist peab kasutaja lugema hoolikalt alltoodud ohutussuuniseid ning tagama, et kõik operaatorid järgiksid neid sondisüsteemi kasutamisel. Juhtimis- või reguleerimisseadmete kasutamine või selles dokumendis mitte loetletud protseduuride tegemine võib põhjustada ohtlikku infrapunakiirgust. Operaatorid peavad saama SP25M-sondisüsteemi ning sellega kaasnevate toodete kasutamise ja rakendamise koolituse enne, kui tohivad asuda tööle masinaga, kuhu vastav süsteem on paigaldatud.



MÄRKUS. Viited on märgitud alljärgnevatel piltidel näidatud tähistusega [†] [‡] [◆] tunnusjoonte alla. Palun veenduge, et mõistaksite selgelt kõiki ohutussuuniseid. Soovitatav on tutvuda järgnevates jaotistes näidatud SP25M-süsteemi komponentidega.

- Süsteemi komponentide ülevaade
- Sondisüsteemi komponentide põhimõtteskeem
- FCR25 muudetava raami põhimõtteskeem
- FCR25 TC muudetava raami põhimõtteskeem

SP25M-sondisüsteemil on sondi +Z-teljel fikseeritud otsatõkkena mehaaniline järeljooksukaitse. Seega peaks masina kontrollsüsteem suutma enne otsatõkkeni jõudmist peatada masina liikumise sondi teljel enne otsatõkkeni jõudmist. Kui see pole nii, siis peavad kasutajal olema töö ajal silmakaitsemed juhuks, kui nõel peaks murduma.

Tuleb hoolikalt jälgida, et nii korpusel kui ka moodulil asuvad optilised aknad (näidatud [◆]) ei saaks viga, kuna need on klaasist ja võivad põhjustada vigastusi.



ETTEVAATUST! SP25M-süsteemi ja sellega seotud toodete mõnel komponendil kasutatakse püsिमagneteid. Need tuleb hoida eemal detailidest, mida võib mõjutada magnetväli, nt andmesalvestussüsteemid, südamestimulaatorid, kellad jne.

SP25M user's guide

www.renishaw.com

LED-ohutus

SP25M-korpus sisaldab sisseehitatud kõrgepingelisi valgusdiodallikaid (näidatud [†]), mis kiirgavad nähtamatut infrapunakiirgust. Sellised allikad on avatud, kui SM25-#- või TM25-20-moodul ei ole paigaldatud.

Mooduli eemaldamine murrab kahe komplekti kaitselüliti kontaktid (näidatud [‡]), et lülitada LED-toide automaatselt välja ja tagada kasutaja ohutus.

Ettenähtud aja pärast tuleb üle vaadata kaitselüliti kontaktid ja kontrollida, et need oleksid kindlasti puhtad ja vabad õhu kaudu levivast saastest, nagu tolm, praht või metallipuru. Väga harva võib selline saaste põhjustada kontaktide lühist ja sellega tösta riski, et LEDidesse saadetakse vool, ilma et moodul oleks ühendatud. Ärge kunagi ühendage voolujuhtivaid objekte omavahel ega kontaktidesse. Järgige osas „Hooldus“ toodud puhastusjuhiseid.

Enne inspekteerimist eemaldage alati SP25M-korpus sondi peast.

SP25M-korpuse või skaneerimismooduli välisümbrise tõsise kahjustuse või mõne osa purunemise korral lülitage KOHE toiteallikas välja, eemaldage osad, ärge proovige neid uuesti kasutada ja pöörduge nõu saamiseks oma tarnija poole.

Ohutusjoonised

Nendel joonistel on funktsioonid tähistusega [†] [‡] [◆], millele on nendes ohutusjuhistes viidatud.

SP25M-sondi korpus

Mooduli kinemaatilist ühendust näitav lõppvaade

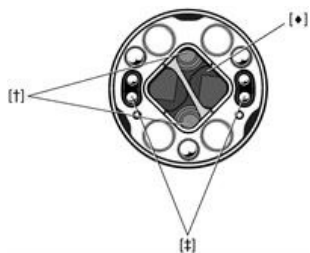

SP25M-mooduli kinemaatiline ühendus

SM25-skaneerimismoodulid

Korpuse kinemaatilist ühendust näitav lõppvaade

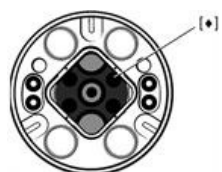

SP25M-korpuse kinemaatiline ühendus

SP25M user's guide

www.renishaw.com

FI - Yleiset turvallisuussuositukset



VAROITUS: Ennen SP25M-luotausjärjestelmän pakettin avaamista ja laitteen asennusta käyttäjän tulee lukea turvallisuusohjeet huolellisesti ja varmistua siitä, että kaikki testausjärjestelmää käyttävät henkilöt noudattavat niitä aina. Sellaisten säätöjen ja asetusten teko tai sellaisten menetelmien käyttö, joita ei tässä mainita, saattaa johtaa vahingolliseen altistumiseen infrapunasäteilylle.

Ennen kuin käyttäjien sallitaan käyttää laitetta, heidän tulee olla koulutettuja käyttämään ja soveltamaan SP25M-kuvaluotausjärjestelmää ja siihen liittyviä tuotteita.



HUOMAA: Viittaukset kuviin merkitään symboleilla [†] [‡] [◆] alla olevissa kuvissa. Varmista, että ymmärrät selvästi kaikki turvallisuusohjeet. Suosittelemme tutustumista kappaleissa esitettyihin SP25M-järjestelmän komponentteihin:

- Järjestelmän komponenttien yleiskuvas
- Anturijärjestelmän komponenttien kaaviokuva
- Joustavan vaihtokehikon FCR25 kaaviokuva
- Joustavan vaihtokehikon FCR25 TC kaaviokuva

SP25M-anturijärjestelmässä on +Z-akselin mekaaninen liikerajan suojaus, joka on kiinteä pysäytysvaste. Koneen ohjausjärjestelmän on tämän vuoksi kyettävä pysäyttämään koneen liike tässä anturin akselisuunnassa, ennen kuin vaste saavutetaan. Jos tämä ei ole mahdollista, käyttäjän tulee pitää silmäsuojusta kärjen hajoamisen varalta.

Käyttäjän tulee huolehtia siitä, ettei sekä rungossa että moduulissa sijaitseva optinen ikkuna (merkitty [◆]) vahingoitu, sillä se on valmistettu lasista ja voi aiheuttaa tapaturman.



VAROITUS: SP25M-järjestelmän ja siihen liittyvien tuotteiden joissain komponenteissa käytetään kestopagneetteja. On tärkeää, ettei kestopagneettien lähelle viedä tuotteita, jotka saattavat reagoida magneettikenttiin, kuten esim. tiedontallennusvälineitä, tahdistimia, kelloja jne.

SP25M user's guide

www.renishaw.com

LED TURVALLISUUS

SP25M:n runko sisältää kiinteitä suurivirtaisia valodiodilähteitä [†], jotka lähettävät näkymättömiä infrapunasäteitä. Nämä säteilylähteet ovat altistettuja, jos SM25-# tai TM25-20-moduulia ei ole kytketty.

Jos moduuli irrotetaan, rikkoutuu kaksi lukituksen kytkimen liitinsarjaa (merkitty [#]), jotka kytkevät pois LED:in virransyötön ja varmistavat näin käyttäjän turvallisuuden.

Lukituksen liittimet tulee tarkistaa sopivin väliajoin, jotta varmistutaan siitä, että ne ovat kuivat, eivätkä ole likaantuneet esim. pölystä, hiekasta, mudasta tms. Epätodennäköisissä olosuhteissa lika saattaa aiheuttaa oikosulun nastoissa, jonka vuoksi kasvaa riski, että valodiodille syötetään virtaa silloin, kun moduulia ei ole kytketty. Älä koskaan aseta virtaajohtavia esineitä liittimiin tai niiden väliin. Noudata kunnossapitoa esittelevässä kappaleessa annettuja puhdistusohjeita.

Irrota SP25M:n runko luotainpästä aina ennen tarkistusta.

Jos laite vahingoittuu pahasti tai murtuu mistä tahansa SP25M-skannerin rungon tai skannausmoduulin ulkokuoren kohdasta, irrota **VÄLITTÖMÄSTI** virtalähde, poista osat äläkä yritä käyttää niitä uudelleen, vaan ota yhteys toimittajaasi lisäohjeiden saamiseksi.

Turvallisuuskuvat

Nämä kaaviot esittävät symboleilla [†] [#] [◆] merkittyjä kuvia, joihin näissä turvallisuusohjeissa viitataan.

SP25M-anturin runko

Loppukuva, joka esittää kinemaattista liitosta moduuliin

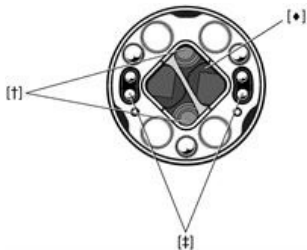

SP25M:n kinemaattinen liitos moduulin

SM25-skannausmoduulit

Loppukuva, joka esittää kinemaattista liitosta runkoon

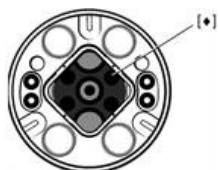

SP25M:n kinemaattinen liitos runkoon

SP25M user's guide

www.renishaw.com

FR - Recommandations générales de sécurité



ATTENTION : Avant de déballer et d'installer le système de palpeur SP25M, l'utilisateur doit lire attentivement les instructions de sécurité suivantes et faire en sorte qu'elles soient respectées en permanence par tous les opérateurs de ce système. L'utilisation de commandes ou de réglages ou la réalisation de procédures autres que ceux spécifiés dans ce document peut entraîner une exposition dangereuse à des rayonnements infrarouges.

Les opérateurs doivent être formés à l'usage et aux applications du système de palpeur SP25M et aux produits qui l'accompagnent et ce, dans le contexte de la machine sur laquelle ce système est installé avant d'être autorisés à utiliser cette machine.

REMARQUE : Le texte ci-après fait référence à des éléments indiqués par [†] [‡] [◆] sur les illustrations qui suivent. Assurez-vous d'avoir clairement compris toutes les instructions de sécurité. Nous vous recommandons de vous familiariser avec les composants du système SP25M, illustrés dans les sections :



- Présentation des composants du système
- Schéma des composants du système de palpation
- Schéma du système automatique de rack changeur FCR25
- Schéma du système automatique de rack changeur FCR25 TC

Le système de palpeur SP25M est doté d'une protection mécanique (butée de choc) contre les dépassements de course sur l'axe +Z du palpeur. Le système de commande de la machine doit donc pouvoir stopper le mouvement de la machine sur cet axe du palpeur avant d'atteindre la butée de choc. Dans le cas contraire, l'utilisateur devra porter des lunettes de protection pendant le fonctionnement en cas de rupture du stylet.

Évitez toute détérioration de la fenêtre optique [signalée par le symbole [◆], située à la fois sur le corps et sur le module. Cette fenêtre est en verre et peut entraîner des blessures.



ATTENTION : Des aimants permanents sont utilisés dans certains composants du système SP25M et ses produits associés. Il faut impérativement les tenir à distance des objets susceptibles d'être affectés par les champs magnétiques tels que les systèmes de stockage de données, stimulateurs cardiaques, montres-bracelets, etc.

SP25M user's guide

www.renishaw.com

Diodes électroluminescentes Sécurité

Le corps du SP25M comporte des LED de grande puissance [signalées par [†], émettant des rayons infrarouges invisibles. Ces sources sont exposées quand un module SM25-# ou un module TM25-20 n'est pas branché.

La dépose du module coupe deux séries de contacts d'interrupteurs de sécurité [indiqués par le symbole [‡]] qui coupent automatiquement l'alimentation des diodes et garantissent la sécurité de l'utilisateur.

Il convient donc d'inspecter les contacts de ces interrupteurs à intervalles réguliers et de contrôler s'ils sont propres et exempts de contaminations issues de l'air ambiant (poussière, débris, copeaux). Dans certains cas peu probables, ce type de contamination pourrait mettre les broches en court-circuit et provoquer le risque de mise sous tension des LED lorsqu'aucun module n'est fixé. Ne jamais connecter d'objets conducteurs aux contacts ou entre eux. Suivez les instructions de nettoyage dans la section Entretien.

Avant l'inspection, démonter toujours le corps du SP25M de la tête fixe ou motorisée.

En cas de détérioration ou de rupture grave de toute partie du corps du SP25M ou du boîtier externe du module de numérisation, mettez IMMÉDIATEMENT hors tension, retirez les pièces, n'essayez pas de les réutiliser et adressez-vous à votre revendeur pour des conseils.

Illustrations de sécurité

Ces schémas montrent les éléments, indiqués par [†] [‡] [◆] auxquels il est fait référence dans ces recommandations de sécurité.

Corps de palpeur SP25M

Vue d'extrémité montrant le montage cinématique au module



Montage cinématique du SP25M au module

Modules de numérisation SM25

Vue d'extrémité montrant le montage cinématique au corps

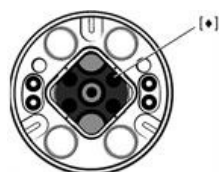

Montage cinématique du SP25M au corps

SP25M user's guide

www.renishaw.com

GA - Moltaí ginearálta sábháilteachta



RABHADH: Ba chóir don úsáideoir na treoracha sábháilteachta thíos a léamh go cúramach sula ndéantar an córas tóireadóra SP25M a dhíphacáil agus a shuiteáil, agus a chinntiú go leanann gach oibreoir a úsáideann an córas tóireadóra i gcónaí iad. Is feidir nochtadh radaíochta infridhearg guaisí a tharlú de dheasca rialtáin a úsáid nó ceartú, nó feidhmiú nósanna imeachta seachas na cinn a shonraítear istigh anseo.

Ní mór oibreoirí a chur faoi oiliúint maidir le húsáid agus le feidhmiú chórais tóireadóra SP25M agus na táirgí a ghabhann leis, i gcomhthéacs an innill ar a bhfuil sé feistithe, sula gceadaítear dóibh an t-inneall a úsáid.

NÓTA: Déantar tagairtí thíos do ghnéithe a léirítear mar [+] [‡] [◆] sna léaráidí thíos. Cinntigh, le do thoil, go dtuigeann tú gach treoir shábháilteachta ina n-iomláine. Moltar bheith eolach ar chomhbhaill an chórais SP25M, mar a léirítear sna codanna seo a leanas:



- Forbhreathnú ar chomhbhaill an chórais
- Léaráid scéimreach ar chomhbhall an chórais tóireadóra
- Léaráid scéimreach ar raca athraithe solúbtha FCR25
- Léaráid scéimreach ar raca athraithe solúbtha FCR25 TC

Tá cosaint mheicniúil ar fhorthaistil sa chóras tóireadóra SP25M atá ar fáil in ais +Z an tóireadóra, le stop tuairte daingean. Ní mór do rialchóras an innill a bheith in ann stop a chur le gluaiseacht an innill, in ais seo an tóireadóra, sula ndéanfar an stop tuairte a bhaint amach. Murab amhlaidh an scéal, caithfidh an t-úsáideoir cosaint súl a chaitheamh agus an gléas á oibriú aige/aici ar eagla go mbrisfeadh an stíleas.

Ní mór aire a thabhairt lena chinntiú nach ndéantar aon damáiste do na fuinneoga optúla (a léirítear mar [◆]), atá ar an gcabhail agus ar an modúl araon, óir tá siad déanta de ghloine agus d'fhéadfaidís gortú a dhéanamh.



RABHADH: Tá buanmhaighnéid i gcuid de chomhpháirteanna an chórais SP25M agus sna táirgí a théann leis. Tá sé tábhachtach iad a choinneáil amach ó earraí mar chórais stórála sonraí, séadairí, uaireadóirí agus araile a d'fheadfadh réimsí maighnéadacha dul i gcion orthu.

SP25M user's guide

www.renishaw.com

Sábháilteacht LED

Tá foinsí LED ardchumhachta leabaithe i gcabhair SP25M (a léirítear mar [†]) a astaíonn radaíocht infridhearg dofheicthe. Nochtar na foinsí sin nuair nach bhfuil SM25-# nó modúl TM25-20 module ceangailte.

Bristear dhá shraith teagmhálacha laisce idirghlasáilte (a léirítear mar [‡]) má bhaintear an modúl, rud a chasann cumhacht LED as go huathoibríoch agus a chinntíonn sábháilteacht an úsáideora.

Ba chóir na teagmhálacha comhghlasáilte seo a iniúchadh ar eatraimh oiriúnacha le cinntiú nach bhfuil aon truailliú aeriompartha orthu, mar dheannach, mionsmionagar nó slisirínéach. I gcúinsí éadóigh, is féidir leis an truailliú sin gearrchiorcadadh na pionnaí a tharraingt agus an riosca a mhéadú dá réir ar chumhacht a sheoladh chuig na LCD, gan an modúl bheith ceangailte. Ná ceangail ábhair sheolta riamh leis na teagmhálaithe nó idir eatarthu. Lean na treoracha maidir le glanadh atá sa chuid a bhaineann le cothabháil.

Ní mór cabhair an SP25M a bhaint ó cheann an tóireadóra i gcónaí sula ndéantar iniúchadh.

I gcás damáiste dháiríre a dhéanamh d'aon chuid den chabhair SP25M nó d' fhorchásáil an mhodúil scanta, dínasc foinse na cumhachta LÁITHREACH, bain na codanna briste di agus ná bain triail as a n-úsáid arís, agus téigh i dteagmháil le do sholáthraí le haghaidh comhairle.

Léaráidí sábháilteachta

Léirítear gnéithe sna léaráidí seo, a léirítear mar [†] [‡] [◆] ar a bhfuil tagairt déanta sna treoracha sábháilteachta seo.

Cabhair tóireadóra SP25M

Ceannamharc a léiríonn alt cinéimiteach go modúl

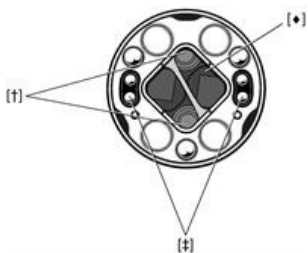

Alt cinéimiteach SP25M go modúl

Modúil scanta SM25

Ceannamharc a léiríonn alt cinéimiteach go cabhair

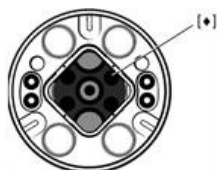

Alt cinéimiteach SP25M go cabhair

SP25M user's guide

www.renishaw.com

HR - UPOZORENJE



OPREZ: Prije raspakivanja i instaliranja sustava sonde SP25M, korisnik mora pažljivo pročitati donje sigurnosne upute i osigurati da ih cijelo vrijeme poštuju svi rukovatelji koji koriste sustav sonde. Korištenje kontrola ili podešavanja, ili karakteristike postupaka drugačije od ovdje navedenih, može prouzročiti izlaganje opasnom infracrvenom zračenju.

Rukovatelji moraju biti obučeni za korištenje i primjenu sustava sonde SP25M i pripadajućih proizvoda, u kontekstu stroja koji je njima opremljen, prije nego što dobiju dopuštenje rada na stroju.



NAPOMENA: Reference se nalaze ispod za značajke označene s [†] [‡] [◆] na donjem crtežu. Uvjerite se da dobro razumijete sve sigurnosne upute. Preporučuje se upoznavanje s komponentama sustava SP25M, kako je prikazano u sljedećim poglavljima:

- Pregled komponenti sustava
- Shematski dijagram komponenti sustava sonde
- Shematski dijagram FCR25 okvira za fleksibilnu promjenu
- Shematski dijagram FCR25 TC stalka za fleksibilnu promjenu

Sustav sonde SP25M ima mehaničku zaštitu od prekomjernog hoda danu u osi +Z, putem fiksnog graničnika. Upravljački sustav stroja zato mora moći zaustaviti kretanje stroja, u ovoj osi sonde, prije dosezanja graničnika. Ako se to ne dogodi, korisnik mora nositi zaštitu za oči tijekom rada za slučaj lomljenja igle.

Potrebno je paziti kako se optički prozori (označeni s [◆]), koji se nalaze na korpusu i na modulu, ne bi oštetili, jer su načinjeni od stakla i mogu prouzročiti ozljede.



OPREZ: U nekim komponentama sustava SP25M i pridruženih proizvoda koriste se trajni magneti. Važno je držati ih podalje od predmeta koji mogu biti zahvaćeni magnetskim poljima, npr. sustavi pohrane podataka, elektrostimulatori srca, satovi itd.

SP25M user's guide

www.renishaw.com

LED sigurnost

Korpus SP25M sadrži ugniježdene visokoenergetske LED izvore (označene s [†]) koji emitiraju nevidljivo infracrveno zračenje. Ti izvori se izlažu ako nije priključen modul SM25-# ili TM25-20.

Uklanjanje modula prekida dva skupa kontakata sigurnosne sklopke (označene s [‡]) na automatsko isključenje LED napajanja i osigurava sigurnost korisnika.

Kontakte sigurnosne sklopke potrebno je pregledavati i provjeravati u odgovarajućim intervalima, kako biste se uvjerali da su čisti i bez zagađenja iz zraka, poput prašine, taloga ili ivera. U malom broju slučajeva, takvo zagađenje moglo bi prouzročiti kratki spoj zatika te time povećati opasnost odašiljanja energije na LED-ove dok modul nije priključen. Nikada nemojte vodljive predmete priključivati na ili između kontakata. Slijedite upute za čišćenje u poglavlju Održavanje.

Prije pregleda uvijek skinite korpus SP25M sa glave sonde.

U slučaju ozbiljnih oštećenja ili pukotina na bilo kojem dijelu korpusa SP25M ili vanjskog kućišta modula za skeniranje, ODMAH odspojite napajanje, uklonite dijelove i nemojte ih pokušavati ponovno koristiti te kontaktirajte svojega dobavljača za savjet.

Sigurnosni prikazi

Ovi dijagrami prikazuju značajke označene s [†] [‡] [◆], koje se navode u ovim sigurnosnim preporukama.

Korpus SP25M sonde

Završni prikaz prikazuje kinematički spoj na modul



SP25M kinematički spoj na modul

Moduli SM25 skeniranja

Završni prikaz prikazuje kinematički spoj na korpus

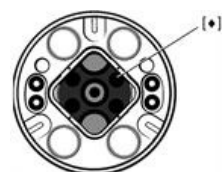

SP25M kinematički spoj na korpus

HU - Általános biztonsági javaslatok



FIGYELMEZTETÉS: Az SP25M mérőrendszer kicsomagolása és telepítése előtt a felhasználónak figyelmesen el kell olvasnia az alábbi biztonsági utasításokat, és gondoskodnia kell arról, hogy azokat a mérőrendszer minden kezelője, mindig betartsa. Az itt leírtaktól eltérő vezérlőszervek, beállítások vagy módszerek alkalmazása esetén a felhasználót veszélyes infravörös sugárzás érheti. A kezelőknek még azt megelőzően képzésben kell részesülniük az SP25M mérőrendszer és a kapcsolódó termékek használata és alkalmazása terén, mielőtt engedélyezik számukra a gép kezelését. A képzés során az érintett termékek használatát azon a gépen kell elsajátítani, amelyre azokat felszerelik.

MEGJEGYZÉS: Az alábbi utalások a lentebb látható ábrákon [†] [‡] [◆] szimbólummal jelölt részekre vonatkoznak. Kérjük, győződjön meg arról, hogy minden biztonsági utasítást világosan megértett. Azt javasoljuk, hogy ismerkedjen meg az SP25M rendszer összetevőivel; a kapcsolódó tudnivalók a következő fejezetekben olvashatók:



- A rendszer összetevőinek áttekintése
- A mérőfejes rendszer összetevőinek sematikus ábrája
- Az FCR25 flexibilis csereállvány sematikus ábrája
- Az FCR25 TC flexibilis csereállvány sematikus ábrája

Az SP25M mérőfejes rendszer mechanikus túlfutásvédelemmel rendelkezik a mérőfej +Z tengelyén, amit egy rögzített ütköző biztosít. A gépet vezérlő rendszernek ezért le kell tudnia állítani a gép mozgását a mérőfej említett tengelyén, mielőtt az elérné az ütközőt. Amennyiben ez nem teljesül, a felhasználónak szemvédő eszközt kell viselnie a gép kezelése közben arra az esetre, ha a tapintószár esetleg eltörne.

Ügyelni kell arra, hogy a készülék házán és a modulon található optikai ablakok (amelyeket az ábrán [◆] jelöl) ne sérülhessenek meg, mivel ezek üvegből készültek, és törés esetén sérülést okozhatnak.



FIGYELMEZTETÉS: Az SP25M rendszer és a kapcsolódó termékek egyes alkatrészeiben állandó mágnesek találhatóak. Ezeket távol kell tartani olyan tárgyaktól, amelyeket a mágneses mezők károsíthatnak, pl. adattároló rendszerek, szívritmus-szabályozók, karórák stb.

SP25M user's guide

www.renishaw.com

A LED fényforrásokkal összefüggő biztonsági tudnivalók

Az SP25M egység házába nagy teljesítményű LED fényforrások vannak beépítve (az ábrán [†] szimbólummal jelölve), amelyek láthatatlan infravörös sugarakat bocsátanak ki. Abban az esetben, ha az SM25-# vagy TM25-20 modul nincs csatlakoztatva, ezek a források a sugarakat közvetlenül a szabadba bocsátják ki.

A modul eltávolításának hatására a két megszakító érintkező-egység (amelyeket az ábrán [‡] szimbólum jelöl) leold, automatikusan megszüntetve a LED fényforrás tápellátását, és garantálva a felhasználó biztonságát.

A megszakító érintkezőket rendszeres időközönként ellenőrizni kell, meggyőződve a tisztaságukról és arról, hogy mentesek a levegőben keringő szennyeződésektől, például portól, törmeléktől vagy forgácstól. Nem túl valószínű, de előfordulhat, hogy az ilyen jellegű szennyeződések rövidre zárják az érintkezők tűskéit, megnövelve annak veszélyét, hogy a modul leszerelt állapotában tápáram jut a LED fényforrásokhoz. Soha ne csatlakoztasson vezetőképes tárgyat az érintkezőkhöz, vagy azok közé. Kövesse a karbantartási fejezet tisztításra vonatkozó utasításait.

Ellenőrzés előtt mindig szerelje le az SP25M egység házát a mérőfejről.

Ha az SP25M egység házának vagy a szkennelő modul külső burkolatának bármelyik része komolyabban sérülne vagy megrepedne, AZONNAL szüntesse meg a tápellátást. A sérült alkatrészeket távolítsa el, és ne kísérelje meg újból felhasználni őket. Segítségért forduljon a forgalmazóhoz.

Biztonsági ábrák

A következő ábrákon [†] [‡] [◆] szimbólum jelöli azokat a funkciókat, amelyekre az itt olvasható biztonsági előírások utalást tesznek.

SP25M mérőfejház

A modulhoz illeszkedő kinematikus csatlakozó alulnézeti képe



A modulhoz illeszkedő SP25M kinematikus csatlakozó

SM25 szkennelő modulok

A házhoz illeszkedő kinematikus csatlakozó alulnézeti képe



A házhoz illeszkedő SP25M kinematikus csatlakozó

SP25M user's guide

www.renishaw.com

IT - Raccomandazioni generali di sicurezza



ATTENZIONE: Prima di estrarre il sistema sonda SP25M dall'imballo e iniziare l'installazione, leggere attentamente le istruzioni riportate di seguito e controllare che vengano sempre rispettate da tutti gli operatori che utilizzano il sistema sonda. L'uso di comandi e regolazioni o l'esecuzione di procedure di natura diversa da quelle qui specificate potrebbero provocare un'esposizione a radiazioni infrarossi nocive.

Prima di attivare una macchina che include il sistema SP25M, gli operatori devono essere addestrati all'uso del sistema e dei prodotti accessori nel contesto in cui essi vengono utilizzati.

NOTA: Di seguito vengono riportati riferimenti a funzioni indicate con [†] [‡] [◆] nelle figure di seguito. Leggere con estrema attenzione tutte le istruzioni di sicurezza. Si consiglia di acquisire familiarità con tutti i componenti del sistema SP25M, mostrati nelle sezioni di seguito:

- Panoramica dei componenti del sistema
- Diagramma schematico dei componenti del sistema
- Diagramma schematico del rack di cambio flessibile FCR25
- Diagramma schematico del rack di cambio flessibile FCR25 TC



Il sistema sonda SP25M dispone di un sistema meccanico di protezione di oltrecorsa lungo l'asse Z+ della sonda costituito da un punto fisso di arresto. Il sistema di controllo della macchina deve essere quindi in grado di fermare il movimento macchina lungo la direzione di tale asse della sonda prima che venga raggiunto il fine corsa meccanico. In caso contrario, l'utente dovrà indossare occhiali protettivi durante l'utilizzo della macchina, per prevenire rischi in caso di rottura dello stilo.

Fare attenzione che le finestre ottiche (indicate con [◆]), posizionate sul corpo e sul modulo, non subiscano danni. Le finestre sono di vetro e in caso di rottura potrebbero provocare lesioni alle persone.



ATTENZIONE: Alcuni componenti del sistema SP25M e di prodotti associati includono magneti. Non avvicinare prodotti che possano essere influenzati da campi magnetici come ad esempio, sistemi di immagazzinamento dati, orologi, pacemaker e così via.

SP25M user's guide

www.renishaw.com

Sorgenti LED – Istruzioni di sicurezza-

Il corpo dell'unità SP25M contiene sorgenti LED ad alta intensità (indicate con [†]) che emettono radiazioni infrarosse non visibili. Tali sorgenti risultano visibili se non si collega un modulo SM25-# o TM25-20.

La rimozione del modulo provoca l'apertura di due serie di contatti di esclusione (indicate con [‡]) che spengono i LED per garantire la sicurezza.

Ispezionare i contatti di esclusione a intervalli regolari, per accertarsi che siano puliti e non coperti da contaminanti portati dall'aria, come polvere, detriti o scorie. Controllare ad intervalli regolari che questi contatti siano sempre puliti ed esenti da impurità che potrebbero causare un corto circuito tra i pin con il rischio di alimentare i LED anche in assenza del modulo. Non inserire mai fra i contatti oggetti fatti con materiali conduttori. Per le operazioni di pulizia attenersi alle istruzioni contenute nella sezione Manutenzione.

Prima dell'ispezione, rimuovere il corpo sonda SP25M dalla testa di supporto della sonda.

In caso di danni gravi o di rottura del corpo della sonda SP25M, scollegare IMMEDIATAMENTE l'alimentazione, rimuovere le parti danneggiate e non tentare di riutilizzarle. Contattare il fornitore per ottenere assistenza.

Illustrazioni sulla sicurezza

Questi diagrammi mostrano le funzioni, indicate con [†] [‡] [◆], che fanno riferimento a queste istruzioni di sicurezza.

Corpo della sonda SP25M

Vista della parte finale con giunto cinematico al modulo

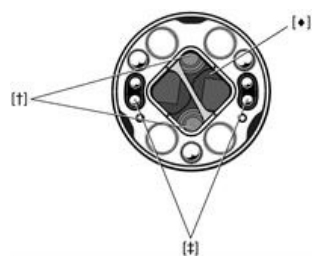

Giunto cinematico SP25M al modulo

Moduli di scansione SM25

Vista della parte finale con giunto cinematico al corpo

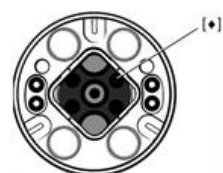

Giunto cinematico SP25M al corpo

SP25M user's guide

www.renishaw.com

JA - 安全性に関する一般的な推奨事項



警告: SP25M プローブシステムの梱包を解いてインストールを始める前に、次の安全性に関する注意事項をよく読み、これらの事項を遵守してプローブシステムを使用してください。ここに記載した以外の方法で制御や調整を行ったり、異なる手順を実行した場合、有害な赤外線放射を浴びる可能性があります。

SP25Mプローブシステムおよびその付属製品を使用する場合、オペレーターは機械の操作を始める前に、実際に取り付けられている機械を使って、その使用方法や安全性等について適切なトレーニングを受けてください。

注意: 以下に示されたイラストに記されている [†] [‡] [◆] に関しては、下記をご参照下さい。すべての安全性に関する注意事項を明確に理解してください。次のセクションに示した図を参照のうえ、SP25M システムの構成を把握しておくことをお勧めします。

- システム構成部品の概観
- プローブシステムの構成図
- FCR25 フレキシブルチェンジラックの構成図
- FCR25 TC フレキシブルチェンジラックの構成図

SP25M プローブシステムにおける +Z 軸のオーバートラベル保護機構は、固定式のバンプストップ構造となっています。安全のため、機械制御によりプローブのバンプストップに到達する前に動きを停止するようにしてください。このような対策をしてない場合は、スタイラスが破損した時の安全を確保するため、必ず保護眼鏡を着用してください。

本体とモジュールにある光学装置用のウィンドウ([◆]で表示)はガラスでできています。破損すると怪我をする危険があるため注意して作業してください。



警告: SP25Mシステムと関連製品の一部コンポーネントには、永久磁石が使用されています。データ格納システム、ペースメーカー、時計など、磁界の影響を受けるものは近づけないでください。

SP25M user's guide

www.renishaw.com

LEDの安全

SP25M 本体に組み込まれた高出力 LED 光源 ([†] で表示) は、不可視赤外線を放射します。SM25-# または TM25-20 モジュールのいずれかを取り付けていない場合、この光源が露出した状態になります。

モジュールを取り外すと、2組の運動保護スイッチの接点 ([‡] で表示) が外れ、LED 出力が自動的に切れる設計となっています。この機構により、ユーザーの安全性を保証しています。

運動保護スイッチの接点に埃やくず、切り粉などの異物がなく、清潔に保たれていることを定期的に検査、確認して下さい。汚れが付着すると、場合によってはピン同士が短絡し、モジュールを取り付けていないのに、LED に電源が供給されてしまうといった危険性が増大します。接点や接点間に伝導性の物体を置かないでください。「メンテナンス」セクション記載のクリーニング手順に沿って清掃を行ってください。

接点を検査する前には必ずプローブヘッドから SP25M 本体を外してください。

SP25M 本体またはスキャニングモジュールが大幅に損傷・破損した場合には、直ちに電源を切り取り外してください。その部品を再利用しようとせずに、サプライヤーへ連絡してください。

安全性に関する図

これらの図には、これらの安全上の推奨事項で参照された機能 ([†] [‡] [◆] で表示) が示されています。

SP25M プローブ本体

モジュールへ取り付ける三点支持機構部を示す端面図

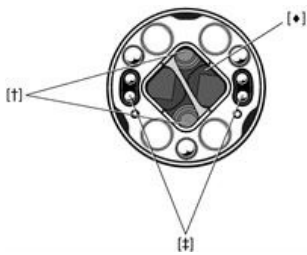

モジュールへの取り付ける SP25M の三点支持機構部

SM25 スキャニングモジュール

本体へ取り付ける三点支持機構部を示す端面図

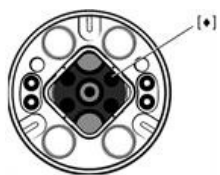

本体へ取り付ける SP25M の三点支持機構部

SP25M user's guide

www.renishaw.com

LT - Bendrosios saugumo rekomendacijos



ATSARGIAI: Prieš išpakuodami ir montuodami zondavimo sistemą SP25M, atidžiai perskaitykite saugos nurodymus ir jų laikykitės kaskart naudodami zondavimo sistemą. Naudojant valdiklius, nuostatas arba procedūras kitaip nei nurodyta šioje instrukcijoje, galima patirti pavojingą infraraudonųjų spindulių apšvitą. Prieš leidžiant naudoti įrenginį, į kurį įmontuojama zondavimo sistema SP25M ir kiti su šia sistema naudojami produktai, operatoriai turi būti išmokyti juo dirbti.



PASTABA: toliau esančiose iliustracijose pateikiamos nuorodos á funkcijas, pažymėtas [†] [‡] [◆]. Įsitikinkite, ar aiškiai supratote visus saugos nurodymus. Rekomenduojama susipažinti su sistemos SP25M dalimis, nurodytomis šiuose skyriuose:

- Sistemos dalių apžvalga
- Zondavimo sistemos dalių schema
- Lankstaus keitimo stovo FCR25 schema
- Lankstaus keitimo stovo FCR25 TC schema

Zondavimo sistema SP25M zondo +Z ašyje turi mechaninę per didelės eigos apsaugą, kurios funkciją atlieka stacionari atrama. Todėl įrenginio valdymo sistema turi sugebėti sustabdyti įrenginio judesį zondo ašimi prieš pasiekiant atramą. Jeigu taip nėra, dirbdamas naudotojas privalo užsidėti apsauginius akinius, kad jie apsaugotų lūžus adatai.

Reikia saugotis, kad optiniai langeliai (pažymėti [◆]), įtaisyti korpuse ir modulyje, nebūtų sudaužyti, nes jie stikliniai ir gali sužeisti.



ATSARGIAI: Kai kuriose sistemos SP25M dalyse ir su ja naudojamuose įtaisuose yra nuolatinių magnetų. Todėl svarbu arti jų nelaikyti prietaisų, kuriuos gali paveikti magnetinis laukas, pavyzdžiui, duomenų atmintinių.

SP25M user's guide

www.renishaw.com

Šviesos diodų sauga

SP25M korpuse yra didelės galios šviesos diodų (pažymėti [+]), šie šaltiniai skleidžia nematomus infraraudonuosius spindulius. Kai modulis SM25-# arba TM25-20 nepritvirtintas, šie šaltiniai yra atviri.

Nuėmus modulį, pertraukiami du blokavimo jungiklių kontaktų rinkiniai (pažymėti [#]), kad būtų automatiškai išjungtas šviesos diodų maitinimas ir užtikrinta naudotojo sauga.

Kartkartėmis reikia patikrinti apsauginių blokuočių jungtis, kad jos būtų švarios ir neapsinešusios dulkelėmis, liekanomis bei smulkiomis drožlėmis. Mažai tikėtina atveju dėl tokio užteršimo gali įvykti kontaktų trumpasis jungimas, todėl padidėja rizika, kad maitinimas šviesos diodams bus tiekiamas, kai modulis nepritvirtintas. Nedėkite elektrai laidžių daiktų ant šių jungčių arba tarp jų. Laikykitės valymo nurodymų, kuriuos rasite skyriuje PRIEŽIŪRA.

Prieš pradėdami tikrinti, SP25M sistemą visada nuimkite nuo zondo galvutės.

Rimtai pažeidus bet kurią SP25M korpuso arba zondavimo modulio išorinio korpuso dalį arba jai trūkus, NEDELSDAMI atjunkite maitinimo šaltinį, nuimkite dalis ir nebandykite jų naudoti pakartotinai bei kreipkitės patarimo į tiekėją.

Saugos iliustracijos

Šiose diagramose parodytos funkcijos, pažymėtos [+], [#], [◆], kurios minimos šiose saugos rekomendacijose.

SP25M zondo korpusas

Galinis vaizdas, kuriame matomas kinematinis sujungimas su moduliu

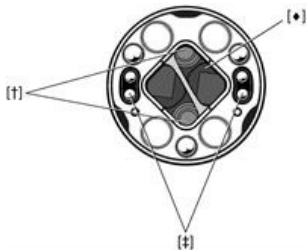

SP25M kinematinis sujungimas su moduliu

SM25 zondavimo moduliai

Galinis vaizdas, kuriame matomas kinematinis sujungimas su korpusu

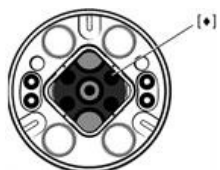

SP25M kinematinis sujungimas su korpusu

SP25M user's guide

www.renishaw.com

LV - Vispārīgi ieteikumi par drošību



UZMANĪBU! Pirms „SP25M” zondes sistēmas izsaiņošanas un uzstādīšanas lietotājam ir uzmanīgi jāizlasa drošības instrukcijas un jāpārlicinās, vai visi zondes sistēmas operatori tās vienmēr ievēro. Lietojot noteikumus nenorādītas kontrolierīces vai aprīkojumu un veicot neatļautas darbības, var rasties bīstams infrasarkanais starojums.

Pirms ierīces izmantošanas operatori ir jāapmāca atbilstoši un pareizi lietot ar iekārtu savienoto „SP25M” zondes sistēmu un aprīkojumu.



PIEZĪME: Turpmāk attēlos atsaucies ir apzīmētas ar [†] [‡] [◆]. Pārlicinieties, vai skaidri saprotat visas drošības instrukcijas. Ieteicams iepazīties ar „SP25M” sistēmas sastāvdaļām, kā norādīts tālāk redzamajās nodaļās.

- Sistēmas sastāvdaļu pārskats
- Shematisks zondes sistēmas sastāvdaļu attēlojums
- Shematisks „FCR25” lokāmās pamatnes attēlojums
- Shematisks „FCR25 TC” lokāmās pamatnes attēlojums

„SP25M” zondes sistēma ir aprīkota ar mehānisku novirzīšanās aizsardzību uz zondes +Z ass ar fiksētu gala aizturi. Iekārtas kontroles sistēmai jāspēj apturēt iekārtas kustība zondes asi pirms gala aiztura sasniegšanas. Darba laikā lietotājam jāvairāk acu aizsargi, lai izvairītos no savainojumiem, adai lūztot.

Nedrīkst pieļaut, ka korpusa un moduļa optiskie logi (apzīmēti ar [◆]) tiek bojāti, – tie ir izgatavoti no stikla un var savainot.



UZMANĪBU! Noteiktās „SP25M” sistēmas un tās aprīkojuma sastāvdaļās ir iestrādāti pastāvīgi magnēti. Svarīgi tos turēt atstātus no tādiem priekšmetiem, kurus var ietekmēt magnētiskais lauks, piem., datu glabāšanas sistēmām, elektrokardiostimulatoriem, pulksteņiem utt.

SP25M user's guide

www.renishaw.com

LED drošība

„SP25M” korpusā ir iebūvēti jaudīgi LED gaismas avoti (apzīmēti ar [†]), kas izstaro neredzamu infrasarkano starojumu. Ja nav pievienoti moduļi SM25-# vai TM25-20, šie gaismas avoti ir atklāti.

Noņemot moduli, nostrādā divi iekšējās bloķēšanas slēdža savienojumu kontakti (apzīmēti ar [‡]), kas automātiski atvieno LED elektroapgādi un garantē lietotāja drošību.

Iekšējās bloķēšanas savienojumi jāpārbauda noteiktos intervālos, lai pārlicinātos, vai tie ir tīri, un uz tiem nav gaisā esošo sārņu, piemēram, putekļu vai zemes daļiņu. Nepiemērotos apstākļos šāds piesārņojums var izraisīt īssavienojumu un tādējādi palielināt elektroapgādes padeves risku LED gaismas avotiem, ja nav pievienots modulis. Nekādā gadījumā nepievienojiet strāvu vadošus priekšmetus kontaktiem vai starp tiem. Ievērojiet nodaļā „Apkope” norādītās tīrīšanas instrukcijas.

Pirms pārbaudes vienmēr izņemiet „SP25M” korpusu no zondes galviņas.

Jebkuras „SP25M” korpusa daļas vai skenēšanas moduļa ārējā apvalka nopietna bojājuma vai pārrāvuma gadījumā NEKAVĒJOTIES atvienojiet barošanas avotu, noņemiet bojātās daļas, nemēģiniet tās izmantot atkārtoti un sazinieties ar piegādātāju, lai saņemtu padomu.

Drošības attēli

Shēmās attēloti elementi (apzīmēti ar [†] [‡] [◆]), uz kuriem ir atsauces šajā drošības instrukcijā.

„SP25M” zondes korpus

Gala skatā ir attēlots kinemātiskais savienojums ar moduli



„SP25M” kinemātiskais savienojums ar moduli

„SM25” skenēšanas moduļi

Gala skatā ir attēlots kinemātiskais savienojums ar korpusu

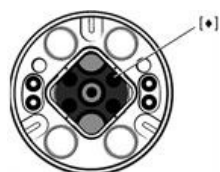

„SP25M” kinemātiskais savienojums ar korpusu

SP25M user's guide

www.renishaw.com

MT - Rakkomandazzjonijiet generali dwar is-sigurtà



ATTENZJONI: Qabel ma joħroġ mill-ippakkjar u jinstalla s-sistema tas-sonda SP25M, l-utent għandu jaqra bl-attenzjoni l-istruzzjonijiet dwar is-sigurtà hawn taħt u jiżgura li jkun segwiti f'kull ħin mill-operaturi kollha li jużaw is-sistema tas-sonda. L-użu ta' kontrolli jew aġġustamenti, jew it-tweġġiq ta' proċeduri ħlief dawk speċifikati hawnhekk, jistgħu jirriżultaw f'espożizzjoni perikoluża għal radjazzjoni infra-red.

L-operaturi għandhom jiġu mħarrġa fl-użu u fl-applikazzjoni tas-sistema tas-sonda SP25M u tal-prodotti li jiġu magħha, fil-kuntest tal-magna li tkun iffittjata magħha, qabel ma jitħallew iħaddmu dik il-magna.

NOTA: Ir-referenzi hawn taħt jirreferu għal karatteristiċi indikati [†] [‡] [◆] fuq l-istampi murija hawn taħt. Jekk jogħġbok aċċerta ruhek li tifhem b'mod ċar l-istruzzjonijiet kollha dwar is-sigurtà. Hu rakkomandat li wieħed ikun familjari mal-komponenti tas-sistema SP25M, kif muri fis-sezzjonijiet li ġejjin.



- Deskrizzjoni fil-qosor tal-komponenti tas-sistema
- Dijagramma skematika tal-komponenti tas-sistema tas-sonda
- Dijagramma skematika tal-FCR25 flexible change rack
- Dijagramma skematika tal-FCR25 TC flexible change rack

Is-sistema tas-sonda SP25M għandha protezzjoni overtravel mekkanika pprovduta fl-assi +Z tas-sonda, permezz ta' bumpstop fissa. Għalhekk, is-sistema tal-kontroll tal-magna trid tkun kapaċi twaqqaf il-moviment tal-magna, f'din l-assi tas-sonda, qabel ma tintlaħaq il-bumpstop. Jekk dan mhuwiex il-każ, l-utent għandu jilbes protezzjoni għall-għajnejn matul it-tħaddim fil-każ ta' ksur tal-istylus.

Għandu jkun kawtela biex jiġi żgurat li l-optical windows (indikati b'◆), li jinsabu kemm fuq il-body kif ukoll fuq il-modulu, ma ssirillhomx ħsara għax huma tal-ħġieġ u jistgħu jikkawżaw korriment.



ATTENZJONI: Kalamiti permanenti jintużaw f'xi partijiet tas-sistema SP25M u prodotti assoċjati magħha. Hu importanti li żżommhom 'il bogħod minn oġġetti li jistgħu jiġu affettwati minn kampijiet manjetiċi, eż. sistemi ta' ħażna tad-dejta, pacemakers u arloġġi, eċċ.

SP25M user's guide

www.renishaw.com

Sigurtà tal-LED

Il-body tal-SP25M fihi sorsi ta' embedded high power LED (indikati b'[†]) li jipproduċu radjazzjoni infra-red invizibbli. Dawn is-sorsi jiġu esposti meta SM25-# jew modulu TM25-20 ma jkunux imwaħħla.

Li tneħħi l-modulu, jaqta' żewġ settijiet ta' interlock switches (indikati b'[‡]) biex jitfi awtomatikament l-enerġija LED u jassigura sigurezza lill-utent.

F'intervalli adattati, il-kuntatti tal-interlock għandhom jiġu eżaminati u ċċekkjati biex jiġi żgurat li jkunu nodfa u ma jkunx fihom kontaminazzjoni li tkun għet mill-arja, bħal trab, partikuli żgħira u rbaba tal-ħadid. F'ċirkustanzi li x'aktarx li mhux se jseħħu, kontaminazzjoni bħal din tista' tikkawża xort tal-pinns u għaldaqstant iżżid ir-riskju li tintbagħat enerġija lil-LEDs, mingħajr ma jkun hemm modulu mwaħħal. M'għandek qatt tikkonnettja oġġetti li jikkonduċu ma', jew bejn, il-kuntatti. Segwi l-istruzzjonijiet dwar it-tindif fit-taqsimha tal-manutenzjoni.

Qabel tibda l-ispezzjoni, dejjem neħħi l-body tal-SP25M minn mal-probe head.

F'każ ta' ħsara serja lil, jew il-qsim ta', kwalunkwe parti tal-body tal-SP25M jew tal-casing ta' barra tal-iscanning module, IMMEDJATAMENT skonnettja s-sors tal-enerġija, neħħi u tippruvax terġa' tuża l-partijiet, u ikkuntattja lill-fornitur tiegħek għal parir.

Stampi dwar is-sigurtà

Dawn id-dijagrammi juru karatteristiċi, indikati b'[†] [‡] [◆] li hemm referenzi għalihom f'dawn ir-rakkomandazzjonijiet dwar is-sigurtà.

Korp tas-sonda SP25M

Dehra tat-tarf li turi kinematic joint mal-modulu

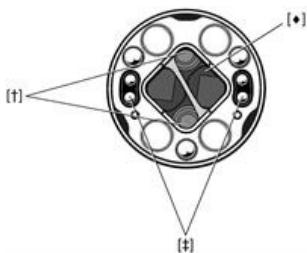

SP25M kinematic joint mal-modulu

SM25 scanning modules

Dehra tat-tarf li turi kinematic joint mal-korp

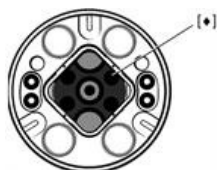

SP25M kinematic joint mal-korp

SP25M user's guide

www.renishaw.com

NL - Algemene veiligheidsaanbevelingen



WAARSCHUWING: Lees voor het uitpakken en installeren van het SP25M tastersysteem eerst de hieronder vermelde veiligheidsinstructies en zorg ervoor dat deze te allen tijde door alle gebruikers van het tastersysteem worden opgevolgd. Het gebruik van andere bedieningsapparatuur, hulpstukken of uitvoeringsprocedures dan hierin vermeld kan leiden tot blootstelling aan gevaarlijke infraroodstraling.

Gebruikers moeten, voordat de machine wordt gebruikt, worden opgeleid in het gebruik en de toepassing van het SP25M tastersysteem en de daarbij behorende producten in samenhang met de machine waarop het systeem is aangesloten.



OPMERKING: Hieronder wordt verwezen naar de tekens [†], [‡] en [◆] in de onderstaande afbeeldingen. Zorg ervoor dat u alle veiligheidsinstructies helder begrijpt. Maakt u zich vertrouwd met de SP25M systeemcomponenten, die te zien zijn in de volgende doorsnedes:

- Overzicht systeemcomponenten
- Schematische weergave van componenten tastersysteem
- Schematische weergave van flexibel wisselrek FCR25
- Schematische weergave van flexibel wisselrek FCR25 TC

Het SP25M tastersysteem heeft een mechanische overtravelbescherming in de tasters +Z-as, bestaande uit een vaste eindaanslag. Het besturingssysteem van de machine moet daarom de machinebeweging langs deze tasteras kunnen stopzetten voordat de eindaanslag wordt bereikt. Als dit niet zo is, dan moet de gebruiker tijdens het werk een veiligheidsbril dragen voor het geval de stylus breekt.

Zorg ervoor dat de optische vensters (aangegeven met [◆]) op zowel het tasterhuis als de module niet beschadigd raken, aangezien ze van glas zijn en dan letsel kunnen veroorzaken.



WAARSCHUWING: Er worden in enkele componenten van het SP25M systeem en de daarbij behorende producten permanente magneten gebruikt. Het is belangrijk om deze weg te houden van voorwerpen die gevoelig zijn voor magnetische velden, zoals gegevensopslagsystemen, pacemakers, horloges enz.

SP25M user's guide

www.renishaw.com

LED veiligheid

In de SP25M zijn krachtige LED-bronnen (aangegeven met [†]) ingebouwd, die onzichtbare infrarode straling uitzenden. Deze LED's worden blootgesteld wanneer de SM25-# of TM25-20 module niet aangebracht is.

Verwijdering van de module verbreekt de contacten van twee veiligheidsschakelaars (aangegeven met [‡]), waardoor de LED-voeding automatisch uitgaat en de gebruiker veilig is.

De schakelaarcontacten moeten regelmatig worden geïnspecteerd en gecontroleerd, zodat vaststaat dat ze schoon zijn en vrij van verontreinigingen uit de lucht zoals stof, vuil en spanen. Zulke vervuiling zou, hoewel het onwaarschijnlijk is, kortsluiting van de pennen kunnen veroorzaken en dus het risico verhogen van ingeschakelde LED's terwijl de module ontbreekt. Sluit op of tussen de contacten nooit geleidende voorwerpen aan. Volg de reinigingsinstructies in het hoofdstuk Onderhoud.

Haal de SP25M altijd voor de inspectie van de tasterkop af.

Mocht het huis van de SP25M of de scanmodule ergens aan de buitenzijde beschadigd raken of breken, schakel dan ONMIDDELIJK de voedingsspanning uit, verwijder de producten en vraag uw leverancier om advies. Gebruik de verwijderde producten niet opnieuw.

Afbeeldingen over veiligheid

Deze afbeeldingen bevatten onderdelen, aangegeven met [†], [‡] en [◆], waar in deze veiligheidsaanbevelingen naar verwezen wordt.

Tasterhuis SP25M

Aanzicht van uiteinde, met kinematische koppeling naar module



Kinematische koppeling SP25M naar module

Scanmodules SM25

Aanzicht van uiteinde, met kinematische koppeling naar tasterhuis



Kinematische koppeling SP25M naar tasterhuis

SP25M user's guide

www.renishaw.com

PL - Ogólne zalecenia dotyczące bezpieczeństwa



PRZESTROGA: Przed rozpakowaniem i zainstalowaniem systemu sondy SP25M użytkownik powinien zapoznać się dokładnie z poniższymi instrukcjami dotyczącymi bezpieczeństwa oraz zapewnić stałe przestrzeganie tych instrukcji przez wszystkich operatorów korzystających z systemu pomiarowego. Skutkiem adyustacji lub regulacji, bądź wykonywania procedur innych niż przedstawione poniżej, może być narażenie na działanie niebezpiecznego promieniowania podczerwieni. Operatorzy, przed dopuszczeniem ich do obsługi maszyny współrzędnościowej, muszą być przeszkoleni w używaniu i zastosowaniu systemu SP25M oraz elementów pomocniczych.



UWAGA: W tekście powołano się na elementy oznaczone symbolami [†] [‡] [◆] jak przedstawiono na poniższych ilustracjach. Należy zadbać o dokładne zrozumienie wszystkich zaleceń dotyczących bezpieczeństwa. Zalecane jest zapoznanie się z częściami składowymi systemu SP25M, jak przedstawiono w następujących sekcjach:

- Przegląd elementów składowych systemu
- Schemat części składowych sondy
- Schemat elastycznego systemu zasobnika FCR25
- Schemat elastycznego systemu zasobnika FCR25 TC

System sondy SP25M jest wyposażony w mechaniczne zabezpieczenie nadmiernego wychylenia trzpienia, działające w osi +Z sondy, w postaci zderzaka krańcowego zamocowanego w ustalonym położeniu. Dlatego też system sterujący obrabiarki musi zapewniać zatrzymanie ruchu obrabiarki w tej osi zanim zostanie osiągnięty zderzak krańcowy. Jeżeli tak nie jest, użytkownik musi podczas eksploatacji maszyny współrzędnościowej zakładać osłonę oczu na wypadek złamania końcówki czujnikowej.

Należy uważać, aby nie dopuścić do uszkodzenia okienek optycznych (oznaczonych [◆]), umieszczonych zarówno na korpusie, jak i na module, ponieważ są one wykonane ze szkła i mogłyby spowodować obrażenia.



PRZESTROGA: W niektórych częściach składowych systemu SP25M i produktach pomocniczych są stosowane magnesy trwałe. Ważne jest, aby utrzymywać je z dala od takich elementów, na które mogą niekorzystnie oddziaływać pola magnetyczne, np. systemy przechowywania danych, stymulatory serca, zegarki itp.

SP25M user's guide

www.renishaw.com

Bezpieczeństwo posługiwania się diodą LED

Korpus SP25M zawiera wbudowane źródła elektroluminescencyjne o dużej mocy (oznaczone [†]), które emitują niewidzialne promieniowanie podczerwone. Źródła te są odsłonięte, gdy nie jest zamontowany moduł SM25-# ani TM25-20.

Wymontowanie tego modułu powoduje rozwarcie dwóch zespołów styków przełącznika blokady (oznakowanie [‡]) w celu automatycznego wyłączenia zasilania diod i zagwarantowania bezpieczeństwa użytkowników.

W stosownych odstępach czasu należy dokonywać przeglądu i kontroli styków blokady w celu upewnienia się, czy są czyste i wolne od zanieczyszczeń zawartych w powietrzu, takich jak kurz, pył lub opiłki. W mało prawdopodobnych okolicznościach takie zanieczyszczenia mogłyby spowodować zwarcie końcówek styków i w ten sposób podnieść ryzyko podania zasilania do diod świecących bez zamontowania modułu. Nigdy nie wolno przyłączać do styków, lub pomiędzy nimi, żadnych przedmiotów przewodzących prąd elektryczny. Postępować zgodnie z zaleceniami rozdziału Konserwacja dotyczącymi czyszczenia.

Przed przystąpieniem do przeglądu należy zawsze zdejmować korpus SP25M z głowicy sondy.

W przypadku poważnego uszkodzenia lub pęknięcia jakiegokolwiek części obudowy SP25M, bądź obudowy zewnętrznej Modułu Skanującego, należy natychmiast odłączyć źródło zasilania, usunąć i nie próbować ponownie użyć zdemontowanych części, następnie niezwłocznie skontaktować się z dostawcą.

Ilustracje związane z bezpieczeństwem

Znajdujące się poniżej diagramy przedstawiają elementy oznaczone symbolami [†] [‡] [◆], do których odniesiono się w niniejszych instrukcjach bezpieczeństwa.

Korpus sondy SP25M

Widok z końca pokazujący złącze kinematyczne modułu

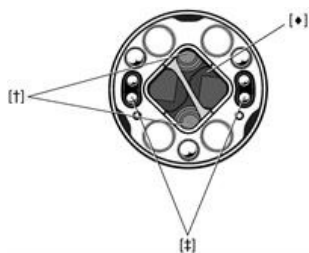

Kinematyczne złącze modułu SP25M

Moduły skanujące SM25

Widok z końca pokazujący kinematyczne złącze korpusu



Kinematyczne złącze korpusu SP25M

PT - Recomendações gerais de segurança



ATENÇÃO : Antes de desembalar e instalar o apalpador SP25M, o usuário deve ler com todo o cuidado as instruções de segurança abaixo e certificar-se de que sempre sejam obedecidas por todos os operadores que utilizarem o sistema. O uso de controles ou ajustes ou a execução de procedimentos diferentes daqueles aqui especificados podem resultar em exposição perigosa à radiação infravermelha.

É necessário que os operadores estejam treinados no uso e na aplicação do apalpador SP25M, dos produtos que o acompanham e na máquina onde o mesmo estiver instalado, antes de serem autorizados a operá-lo.



NOTA: O texto a seguir contém referências sobre características indicadas por [†] [‡] [◆] nas figuras mostradas abaixo. Certifique-se que todas as instruções de segurança foram compreendidas. É recomendável familiarizar-se com os componentes do sistema SP25M mostrados nas seções a seguir:

- Visão geral dos componentes do sistema
- Diagrama dos componentes do sistema de apalpador
- Diagrama do magazine de troca flexível FCR25
- Diagrama do magazine de troca flexível FCR25 TC

O apalpador SP25M possui uma proteção mecânica de fim de curso, através de um limitador fixo no eixo +Z do apalpador. Portanto, o sistema de comando da máquina deve ser capaz de parar seu movimento neste eixo do apalpador, antes de atingir o limitador. Caso isso não seja possível, o usuário deverá utilizar óculos de proteção durante a operação, para o caso de quebra da ponta.

Deve ser assegurado que as janelas ópticas (indicadas como [◆]), localizadas no corpo e no módulo, não sejam danificadas, pois são feitas de vidro e podem causar lesões.



ATENÇÃO : Alguns componentes do sistema SP25M e de produtos associados fazem uso de ímãs permanentes. É importante manter estes ímãs afastados de quaisquer objetos que possam ser afetados por campos magnéticos, como sistemas de armazenamento de dados, marca-passos, relógios, etc.

SP25M user's guide

www.renishaw.com

LED de segurança

O corpo do SP25M contém em seu interior LEDs de alta potência (indicados por [†]) que emitem radiação infravermelha. Estas fontes ficam expostas se um módulo SM25-# ou TM25-20 não estiver instalado.

A retirada do módulo abre dois conjuntos de contatos [indicados por [‡]] que automaticamente desligam a energia do LED e garantem a segurança do usuário.

Os contatos devem ser inspecionados periodicamente, para assegurar que continuam limpos e isentos de contaminação, como pó, resíduos ou limalhas. Em uma circunstância improvável, esta contaminação poderia causar um curto-circuito nos pinos, aumentando o risco de transmitir energia aos LEDs, sem haver um módulo instalado. Nunca conecte objetos condutores aos contatos. Observar as instruções de limpeza na seção de Manutenção.

Retire sempre o corpo do SP25M do cabeçote antes de examiná-lo.

Em caso de dano grave ou ruptura de qualquer componente da carcaça externa do corpo ou do módulo de digitalização do SP25M, desconecte IMEDIATAMENTE a fonte de energia, retire o componente e não tente reaproveitá-lo. Procure o seu fornecedor para receber instruções.

Figuras de segurança

Estes diagramas mostram características , indicadas por [†] [‡] [◆], que são mencionadas nestas recomendações de segurança.

Corpo do apalpador SP25M

Vista de frente mostrando o acoplamento cinético para o módulo

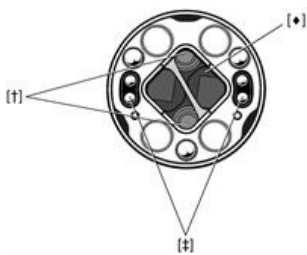

SP25M acoplamento cinético para o módulo

Módulos de digitalização SM25

Vista de frente mostrando o acoplamento cinético para o corpo

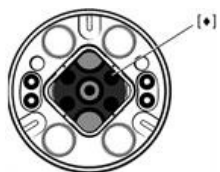

SP25M acoplamento cinético para o corpo

SP25M user's guide

www.renishaw.com

RO - Recomandări generale de protecția muncii



ATENȚIE: Înainte de a despacheta și instala sistemul SP25M, utilizatorul trebuie să citească cu atenție instrucțiunile de securitate de mai jos și să se asigure că ele vor fi respectate de toți operatorii ce folosesc sistemul. Utilizarea de operații, proceduri sau reglaje, altele decât cele specificate în prezenta instrucțiune, poate duce la expunere periculoasă la radiații infraroșii.

Operatorii trebuie instruiți pentru utilizarea sistemului SP25M și a produselor asociate, în contextul echipării mașinii, înainte de a li se permite operarea acesteia.



NOTĂ: Mai jos se fac referiri la elementele indicate [†] [‡] [◆] pe ilustrații. Mai jos se fac referiri la elementele indicate pe ilustrații. Se recomandă familiarizarea cu componentele sistemului SP25 M după cum este prezentat mai jos:

- Prezentarea componentelor sistemului
- Schema bloc a componentelor sistemului
- Schema bloc a schimbătorului de scule flexibil FCR25
- Schema bloc a schimbătorului de scule flexibil FCR25 TC

Sistemul SP25M dispune de o protecție mecanică de suprasarcină pe axa +Z a probei, printr-un tampon fix. Sistemul de control al mașinii trebuie să fie capabil să oprească mișcarea acesteia pe direcția axei +Z, înainte ca tamponul să fie atins. Dacă acest lucru nu este posibil, operatorul trebuie să poarte ochelari de protecție care să îl protejeze în cazul spargerii palpatorului propriu-zis.

Trebuie să vă asigurați că ferestrele optice (indicate [◆]), situate atât pe corp cât și pe modul, nu sunt deteriorate deoarece sunt făcute din sticlă și ar putea cauza răniri.



ATENȚIE: În unele componente ale sistemului SP25M sunt folosiți magneti permanenți. Este recomandată pastrarea distanței față de aceștia a dispozitivelor care pot fi afectate de câmp magnetic cum ar fi: sisteme de stocare de date, pacemaker, ceasuri etc.

SP25M user's guide

www.renishaw.com

Siguranta LED

Corpul SP25M conține surse LED integrate de mare putere (indicate [+]), care emit radiații infraroșii invizibile. Aceste surse sunt expuse atunci cand nu este atasat nici unul dintre modulele SM25* sau TM25-20

Înlăturarea modulului întrerupe două seturi de contacte ale comutatorului de blocare (indicat [#]) pentru a opri automat alimentarea LED-urilor și pentru a asigura siguranța utilizatorului.

La intervale potrivite, contactele de interblocare trebuie să fie verificate și controlate pentru a fi siguri că sunt curate și necontaminate cu praf, resturi sau așchii metalice. In situatii rare, contaminarea contactelor cu murdarie poate duce la scurtcircuitate între terminale, determinand riscul de a alimenta sursa LED chiar fara ca un modul sa fie atasat corpului. Nu conectați niciodată obiecte conductoare de curent la sau între contacte. Pentru curatare urmati instructiunile din sectiunea Intretinere.

Înainte de a începe verificarea, demontați întotdeauna corpul SP25M de pe cap.

In eventualitatea defectarii puternice sau chiar a ruperii oricarei parti a corpului SP25M sau a unui modul de scanare, deconectati IMEDIAT alimentarea cu energie, demontati sistemul, nu mai incercati sa il utilizati si contactati furnizorul pentru instructiuni.

Ilustratii de securitate

Aceste diagrame arată caracteristici, indicate [+], [#], [◆] la care se face referință în aceste recomandări privind siguranța.

Corpul probei SP25M

Vedere dinspre capat reprezentand imbinarea cinematica cu modulul



Imbinarea cinematica SP25M cu modulul

Modulele de scanare SP25M

Vedere dinspre capat reprezentand imbinarea cinematica cu corpul

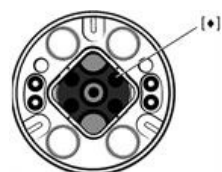

Imbinarea cinematica SP25M cu corpul

SK - Všeobecné bezpečnostné odporúčania



UPOZORNENIE: Pred vybalením a nainštalovaním snímacieho systému SP25M si používateľ musí dôkladne prečítať bezpečnostné pokyny uvedené nižšie a zaručiť ich neustále dodržiavanie všetkými pracovníkmi obsluhujúcimi snímací systém. Používanie ovládacích prvkov, nastavovanie alebo vykonávanie iných postupov, než sú uvedené v tomto dokumente, môže viesť k nebezpečnej expozícii infračerveným žiarením.

Obsluha musí byť predtým, než sa jej umožní ovládanie príslušného stroja, vyškolená v používaní a aplikácii snímacieho systému SP25M a príslušných produktov v kontexte stroja, do ktorého sa montuje.

POZNÁMKA: Nižšie sa odkazuje na funkcie označené ikonou [†] [‡] [◆] na obrázkoch uvedených nižšie. Všetkým bezpečnostným pokynom musíte dobre porozumieť. Odporúčame oboznámiť sa s komponentmi systému SP25M, ktoré sú vyobrazené v nasledujúcich sekciách.



- Prehľad systémových komponentov
- Schematický diagram komponentov snímacieho systému
- Schematický diagram flexibilnej výmennej konzoly FCR25
- Schematický diagram flexibilnej výmennej konzoly FCR25 TC

Snímací systém SP25M obsahuje mechanickú ochranu pred prekročením krajnej polohy, ktorú tvorí pevný koncový doraz v osi +Z sondy. Systém ovládania stroja musí byť preto schopný zastaviť pohyb stroja v smere tejto osi sondy ešte pred dosiahnutím koncového dorazu. V opačnom prípade musí užívateľ nosiť počas prevádzky ochranu očí pre prípad prasknutia snímacieho hrotu.

Musí sa dávať pozor, aby nedošlo k poškodeniu optických okienok (označených ikonou [◆]), ktoré sú umiestnené na tele hlavice aj module, pretože sú vyrobené zo skla a mohli by spôsobiť poranenie.



UPOZORNENIE: V niektorých súčiastiach systému SP25M a sprievodných produktoch sa používajú permanentné magnety. Je dôležité udržiavať ich mimo predmetov, ktoré môžu byť ovplyvnené magnetickými poľami, ako sú napríklad systémy na ukladanie údajov, kardiostimulátory, hodinky a podobne.

SP25M user's guide

www.renishaw.com

Bezpečnosť diód LED

Telo systému SP25M obsahuje integrované vysokovýkonné diódy LED (označené ikonou [†]), ktoré emitujú neviditeľné infračervené žiarenie. K odkrytiu týchto diódových zdrojov dôjde, keď nie je pripojený modul SM25-# alebo TM25-20.

Odstránením modulu sa rozpoja dve súpravy kontaktov bezpečnostných blokovacích spínačov (označené ikonou [‡]), čím sa automaticky vypne napájanie diód LED a zaručí sa bezpečnosť používateľa.

Bezpečnostné blokovacie kontakty treba vo vhodných intervaloch prezerat' a kontrolovať, aby sa zaručilo, že sú čisté a bez nečistôt, ktoré sa k nim mohli dostať zo vzduchu, ako napríklad prach, pevné častice alebo piliny. V nepravdepodobných prípadoch by takéto znečistenie mohlo spôsobiť skrat vývodov a následné zvýšenie rizika prívodu napájania k diódam LED, a to aj bez pripojeného modulu. Ku kontaktom a medzi ne nikdy nepripájajte vodivé predmety. Dodržiavajte pokyny na čistenie uvedené v časti venovanej údržbe.

Pred prehliadkou vždy odstráňte telo sondy SP25M zo snímacej hlavice.

V prípade závažného poškodenia alebo prasknutia ľubovoľnej časti tela snímacieho systému SP25M alebo vonkajšieho puzdra snímacieho modulu OKAMŽITE odpojte zdroj napájania, demontujte príslušné diely a nepokúšajte sa ich znova použiť. Ďalší postup konzultujte s dodávateľom.

Bezpečnostné schémy

Tieto diagramy znázorňujú funkcie (označené ikonami [†] [‡] [◆]), na ktoré sa odkazuje v týchto bezpečnostných odporúčaniach.

Telo sondy SP25M

Koncový pohľad zobrazujúci kinematické spojenie s modulom

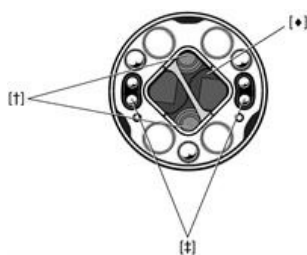

Kinematické spojenie SP25M s modulom

Snímacie moduly SM25

Koncový pohľad zobrazujúci kinematické spojenie s telom sondy

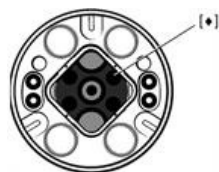

Kinematické spojenie SP25M s telom sondy

SP25M user's guide

www.renishaw.com

SL - Splošna varnostna priporočila



POZOR: Uporabnik mora pred jemanjem iz embalaže in montažo merilnega sistema SP25M skrbno prebrati spodnja varnostna navodila ter poskrbeti, da jih bodo dosledno upoštevali vsi operaterji, ki bodo imeli opravka z merilnim sistemom. Uporaba ukazov, nastavitvev ali postopkov, ki odstopajo od tukaj opisanih, lahko povzroči izpostavitve nevarnemu infrardečemu sevanju. Preden začnejo upravljati s strojem, morajo operaterji opraviti usposabljanje za uporabo merilnega sistema SP25M in spremljajočih izdelkov v kontekstu stroja, na katerem je sistem nameščen.

OPOMBA: V besedilu so navedene pozicije s spodnjih ilustracij, ki so označene z [†] [‡] [◆]. Poskrbite, da boste pred uporabo jasno razumeli vsa varnostna navodila. Priporočamo vam, da se seznanite s komponentami sistema SP25M, ki so opisane v naslednjih poglavjih:



- Pregled komponent sistema
- Shematski prikaz komponent merilnega sistema
- Shematski prikaz sistema za fleksibilno menjavo modulov FCR25
- Shematski prikaz sistema za fleksibilno menjavo modulov FCR25 TC

Merilni sistem SP25M ima mehansko zaščito pred predolgim hodom po osi glave +Z (fiksni prislon). Krmilni sistem stroja mora zaustaviti gibanje stroja po tej osi glave še preden je dosežen končni položaj. V nasprotnem primeru mora operater med delom uporabljati zaščito za oči, ki ga bo zavarovala v primeru loma tipala.

Pazite, da se ne razbije optično okno na telesu in na modulu [označeno z [◆]], ker je izdelano iz stekla in se lahko poškodujete.



POZOR: V nekaterih komponentah sistema SP25M in spremljajočih izdelkih so trajni magneti. Pazite, da take komponente ne pridejo v bližino predmetov, na katere lahko vplivajo magnetna polja; to so npr. sistemi za shranjevanje podatkov, srčni spodbujevalniki, ure itd.

SP25M user's guide

www.renishaw.com

Varnost LED-izvora

V telesu SP25M so vgrajeni LED-izvori visoke moči (označeni z [†]), ki oddajajo nevidno infrardeče sevanje. Ti izvori so izpostavljeni, ko ni nameščen modul SM25-# ali TM25-20.

Ob odstranitvi modula se prekineta dva para zapornih stikalnih kontaktov, označena z [‡]. LED-izvor se pri tem samodejno izklopi in tako zavaruje uporabnika.

Zaporne kontakte redno pregledujte glede čistoče in se prepričajte, da niso umazani s kontaminanti, ki se prenašajo po zračni poti (npr. prah, delci, odrezki). V posebej neugodnih pogojih bi takšna kontaminacija lahko povzročila kratek stik med pini in s tem nevarnost aktivnega napajanja LED-izvorov tudi pri odstranjenem modulu. Nikoli ne priključite prevodnih predmetov na ali med kontakte. Upoštevajte navodila za čiščenje v poglavju Vzdrževanje.

Pred pregledovanjem vedno odstranite telo SP25M z merilne glave.

V primeru večje poškodbe oziroma loma kateregakoli dela telesa SP25M ali zunanjšega ohišja modula za skeniranje TAKOJ odklopite napajanje, odstranite dele in jih ne poskušajte ponovno uporabiti. Za nasvet se obrnite na vašega dobavitelja.

Varnostne ilustracije

Ti diagrami prikazujejo dele, označene z [†] [‡] [◆], na katere se sklicujejo ta varnostna navodila.

Telo merilne glave SP25M

Pogled od zadaj, ki kaže kinematično pritrditev na modul

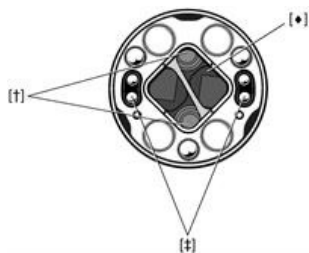

Kinematična pritrditev SP25M na modul

Moduli za skeniranje SM25

Pogled od zadaj, ki kaže kinematično pritrditev na telo

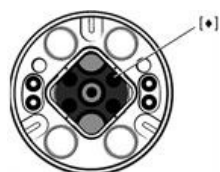

Kinematična pritrditev SP25M na telo

SP25M user's guide

www.renishaw.com

SV - Allmänna säkerhetsrekommendationer



VAR FÖRSIKTIG: Innan probsystem SP25M packas upp och installeras, bör du läsa nedanstående säkerhetsföreskrifter noggrant, och se till att de alltid följs av alla operatörer som använder probsystemet. Om inställningarna ändras, eller om man vidtar andra åtgärder än de som anges i dessa instruktioner, kan det leda till att man utsätter sig för farlig infraröd strålning. Operatörerna måste övas i hur man använder och sätter upp probsystem SP25M och tillhörande produkter, i anslutning till den maskin där den är monterad, innan de tillåts köra maskinen.

OBS: I illustrationerna nedan återfinns referenser till olika funktioner som indikeras med [+] [✦] [◆]. Se till att du förstår alla säkerhetsföreskrifter utan problem. Vi rekommenderar att du bekantar dig med komponenterna i SP25M-systemet, så som det visas i följande avsnitt:



- Översikt över systemets komponenter
- Schematisk översikt över probsystemets komponenter
- Schematisk översikt över FCR25 flexibelt växlingsrack
- Schematisk översikt över FCR25 TC flexibelt växlingsrack

Probsystemet SP25M har ett mekaniskt skydd mot överrörelse i +Z-riktningen i form av ett fast ändstopp. Maskinens styrsystem måste därför kunna stoppa rörelsen i denna riktning innan proben kommer till ändstoppet. Om detta inte är möjligt, måste operatören använda skyddsglasögon under driften, för den händelse att mätspetsen bryts av.

Var försiktig så att de optiska fönstren (märkta [◆]), som finns på huset och modulen, inte skadas, eftersom de är gjorda av glas och kan orsaka personskador.



VAR FÖRSIKTIG: Permanentmagneter används i vissa komponenter i system SP25M och tillhörande produkter. Det är viktigt att hålla avstånd mellan dessa och sådant som kan skadas av magnetfält, t.ex. datalagringsenheter, pacemakers, klockor m.m.

SP25M user's guide

www.renishaw.com

LED säkerhet

SP25M-huset innehåller inbyggda högeffektsdioder (märkta [†]), och avger osynlig infraröd strålning. Dessa strålningskällor exponeras när ingen av modulerna SM25-# eller TM25-20 är monterad.

När modulen tas bort bryts strömmen genom två förreglingskontakter (märkta [‡]), som automatiskt stänger av lysdioderna och garanterar säkerheten för användaren.

Inspektera förreglingskontakterna med lämpliga intervall och kontrollera att de är rena och fria från luftburen smuts, såsom damm, skräp och spån. Under vissa osannolika omständigheter kan sådan nedsmutsning medföra kortslutning av kontakterna och öka risken för att ström skickas till lysdioderna, utan att någon modul monterats. Anslut aldrig elektriskt ledande föremål till – eller mellan – kontakterna. Följ rengöringsanvisningarna i underhållsavsnittet.

Ta alltid bort SP25M-huset från probhuvudet innan det kontrolleras.

I händelse av allvarliga skador eller sprickor på någon del av SP25M-huset eller probhuvudets yttre hölje ska strömmen OMEDELBART stängas av. Avlägsna och återanvänd ej provdelarna. Kontakta er leverantör för råd.

Säkerhetsillustrationer

Dessa figurer visar funktioner som visas med [†] [‡] [◆] och som beskrivs i dessa säkerhetsrekommendationer.

SP25M probkropp

Sedd bakifrån, med kinematisk koppling till modulen

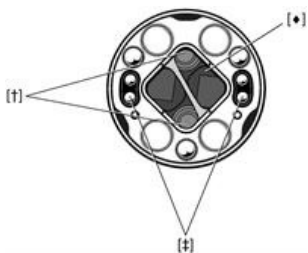

SP25M kinematisk koppling till modul

SM25 scanningmoduler

Sedd bakifrån, med kinematisk koppling till kroppen

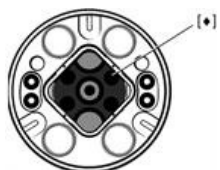

SP25M kinematisk koppling till kroppen

SP25M user's guide

www.renishaw.com

TW - 般安全建議



注意: 在拆開包裝和安裝SP25M測頭系統之前, 使用者應詳細閱讀該下方的安全指示, 並保證使用測頭系統的所有操作者隨時都能確實遵守這些安全指示. 在使用控制元件或調整元件或者操作時, 若不按照本文所述的步驟進行, 可能受到有害的紅外線輻射的照射。

操作者必須接受有關在機器適合之背景中使用與應用SP25M測頭系統及其相應產品的培訓, 然後才能獲准操作機器。

備註: 下圖所示 [†] [‡] [◆] 符號的功能其參考說明如下。請確保您明確瞭解所有安全指示. 建議您熟悉下列章節中所示的 SP25M 系統組件。



- 系統組件概述
- 測頭系統組件示意圖
- FCR25靈活更換架示意圖
- FCR25 TC靈活更換架示意圖

SP25M測頭系統由一個固定緩衝塊在測頭+Z軸中提供機械過行程保護。因此, 加工機控制系統必須能夠在接觸緩衝塊之前在測頭的此軸停止加工機的運動. 否則, 使用者必須在作業期間配戴護目鏡, 以防探針破損。

主體和模組上的光學視窗(以 [◆] 表示)係由玻璃製成, 務必小心確保其不受損壞, 否則可能會造成傷害。



注意: 在某些SP25M系統的組件及其關聯產品中使用了永久磁體. 請特別注意盡量使可能受到磁場影響的物體遠離裝置, 諸如資料儲存系統、心臟起搏器和手錶等等。

SP25M user's guide

www.renishaw.com

LED安全

SP25M 主體包含嵌入式高功率 LED 光源(以 [†] 表示), 可放射出隱形紅外線輻射。當不附加SM25-#或TM25-20模組時, 這些光源會暴露出來。

移除模組即會斷開兩組互鎖開關觸點(以 [†] 表示), 以自動關閉 LED 電源並確保使用者安全。

應在適當的時間間隔檢測和檢查互鎖觸點, 以保證其清潔且沒有灰塵、碎屑或切屑等空氣污染物。在少數未附加模組的情況下, 此類污染物能夠引起引腳短路並增加向LED傳送電能的風險。切勿將導體連接至觸點或在觸點之間連接。遵循維護章節中的清潔指示。

在檢測之前, 務必從測頭座上移除SP25M主體。

若SP25M主體的任何部分或掃描模組的外殼發生嚴重損壞或斷裂, 立即斷開電源, 移除部件, 切勿再使用該部件並聯絡您的供應商獲取建議。

安全圖示

這些 [†] [†] [◆] 圖示所示的功能皆是參照安全建議中所提及者。

SP25M測頭主體

顯示模組運動接頭的端視圖

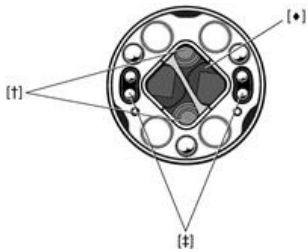

SP25M模組運動接頭

SM25掃描模組

顯示主體運動接頭的端視圖

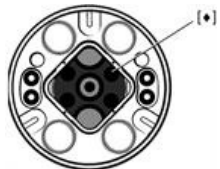

SP25M主體運動接頭

SP25M user's guide

www.renishaw.com

ZH - 般安全建议



小心:在拆包和安装SP25M测头系统之前,用户应仔细阅读下述安全说明,并确保使用测头系统的所有操作人员都能始终遵守这些说明。在使用控制元件或调整元件或者进行操作时,若不按照本文所述的步骤进行,可能会受到有害的红外线辐射的照射。操作人员必须在配装测头的机器环境下接受SP25M测头系统及其随附产品的使用及应用培训,然后才能获准操作机器。

注:此处涉及的部分在如下镜组中由[+] [♦]表示。请确保您明确了解所有安全说明。建议您熟悉下列章节中所示的SP25M系统组件:



- 系统组件概述
- 测头系统组件示意图
- FCR25自动交换架示意图
- FCR25 TC自动交换架示意图

SP25M测头系统由一个固定缓冲块在测头+Z轴上提供机械越程保护。因此,机器控制系统必须能够在接触缓冲块之前,就在测头的这个轴上停止机器的运动。否则,用户在操作过程中必须配戴护目镜,以防测针破损。

小心确保测头本体和模块上的光学窗口(如[♦]所示)不会被损坏,因为它们是用玻璃制成的,如果损坏,可能会造成人身伤害。



小心:在某些SP25M系统的组件及其相关产品中使用了永久磁体。请特别注意,尽量使可能受到磁场影响的物体远离装置,诸如数据存储系统、心脏起搏器和手表等。

SP25M user's guide

www.renishaw.com

LED安全须知

SP25M本体包含内置高功率LED光源(如[*])所示,可发出不可见的红外线辐射。当未连接SM25-#或TM25-20模块时,这些光源会透出来。

拆下模块时会断开两组互锁开关触点(如[*])所示,以自动关闭LED电源,保证用户安全。

应按适当的时间间隔检测并检查互锁触点,确保其清洁,没有灰尘、碎屑或切屑等空气污染物。在少数情况下,未连接模块时,此类污染物可能会造成针脚短路,由此带来向LED供电的风险。切勿将导体连接至触点或在触点之间连接。遵循维护章节中的清洁说明。

在检测之前,务必从测座上拆下SP25M本体。

如果SP25M本体的任何部分或扫描模块的外壳出现严重损坏或破裂,须立即断开电源,拆下该部件,不要再尝试使用,并向您的供应商进行咨询。

安全图示

此处涉及的部分在如下镜组中由[*][*][◆]表示。

SP25M测头本体

显示接合模块的机械定位接头的端视图

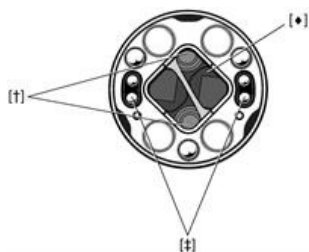

SP25M接合模块的机械定位接头

SM25扫描模块

显示接合本体的机械定位接头的端视图

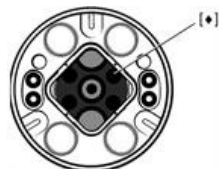

SP25M接合本体的机械定位接头

Renishaw plc
New Mills, Wotton-under-Edge
Gloucestershire, GL12 8JR
United Kingdom

T +44 (0)1453 524524
F +44 (0)1453 524901
www.renishaw.com/cmmsupport



**For worldwide contact details,
please visit our main website at
www.renishaw.com/contact**